



LABORATORY PRODUCTS CATALOG | 4TH EDITION

 **HANNA**[®]
instruments
With Great Products, Come Great Results™
.....
www.hannainst.com

World Headquarters

HANNA instruments Inc.
Highland Industrial Park, 584 Park East Drive Woonsocket, RI 02895 USA
P: (800) 426-6287 F: (401) 762-5064 E: sales@hannainst.com
www.hannainst.com/usa

USA Laboratory Division

HANNA instruments Inc.
3820 Packard Road, Suite 120, Ann Arbor, MI 48108, USA
P: (800) 504-2662 F: (734) 971-8155 E: laboratory@hannainst.com



Contacts Worldwide

Argentina

HANNA instruments® Argentina s.a.
Saavedra 1023
(C 1229 ACK) Buenos Aires
Argentina
P: (11) 4308.1905 / 4308.4807
F: (11) 4308.1904
E: ventas@hannaarg.com

Australia

HANNA instruments® Pty Ltd
18 Fiveways Boulevard
Keysborough Vic 3173
Australia
P: (03) 9769.0666
F: (03) 9769.0699
E: hannains@hannainst.com.au
W: www.hannainst.com.au

Belgium

HANNA instruments® BVBA
Winninglaan 8
9140 Temse
Belgium
P: (03) 710.9340
F: (03) 710.9359
E-mail: info@hannainst.be
W: www.hannainst.be

Brazil

HANNA instruments® Brasil Importação e Exportação LTDA
Rua Pretoria 1027/1039
Bairro Vila Formosa
CEP 03416-000 Sao Paulo - SP
Brazil
P: (55) 66723008
F: (55) 66723695
E: vendas@hannainst.com.br
W: www.hannainst.com.br

Canada

HANNA instruments® Canada Inc.
3156 Industrial Boulevard
Laval, Quebec, H7L 4P7
Canada
P: (450) 629.1444
F: (450) 629.3335
E: info@hannacan.com
W: www.hannacan.com

Chile

HANNA instruments® Equipos Ltda.
Dr. Manuel Barros Borgoño 246
Providencia (Metro M. Montt)
Santiago
Chile
P: (2) 2361400
F: (2) 2364009
E: ventas@hannachile.com
W: www.hannachile.com

China

Beijing HANNA instruments® Science & Technology Co., Ltd.
3-3A01, Blk 5 Webok House
No. 1 Wei gong cun St.
Hai Dian District,
Beijing 100081, China
P: (10) 88570068
F: (10) 88570060

Egypt

HANNA instruments® Egypt Ltd.
27 Makram Ebied St.
Nasr City, Cairo
Egypt
P: (02) 2758683 / 6717098
F: (02) 2758683
E: hannaegypt@hannaegypt.com

France

HANNA instruments® France
Parc d'Activité des Tanneries
1, rue du Tanin
BP133 - Lingolsheim
F-67833 Tanneries Cedex
France
P: (03) 8876.9188
F: (03) 8876.5880
E: info@hannafr.com
W: www.hanna-france.com

Germany

HANNA instruments® Deutschland GmbH
Lazarus-Mannheimer-Strasse 2-6
D-77694 Kehl am Rhein
Germany
P: (07851) 9129-0
F: (07851) 9129-99
E: info@hanna-de.com
W: www.hanna-de.com

Greece

HANNA instruments® Hellas Ltd.
Marni 10
10433 Athens
Greece
P: (210) 823.5192
F: (210) 884.0210

Hungary

HANNA instruments® Hungary KFT
Alsokikő sor 11
6726 Szeged
Hungary
P: (0036) 62.461.514
E: hanna@hih.hu
W: www.hannainst.hu

India

HANNA instruments® (India) Pvt. Ltd.
414/415, Raheja Arcade, Plot No. 61
Sector 11, CBD Belapur,
Navi Mumbai - 400614
P: 91-22-2756 6435 / 2756 6436
F: 91-22-2756 6436
E: hanna@india@gmail.com

Indonesia

PT. HANNA instruments® Indotama
Perkantoran Plaza Pasifik
Jl. Raya Boulevard Barat Blok A4 No.
C83 & C85
Kelapa Gading Permai
Jakarta Utara 14240
Indonesia
P: 62 (021) 4525106, 458 42941,
451 7775, 451 7579
F: 62 (021) 458 4294242942

Italy

HANNA *Italia Srl*
Padova (amministrazione, assistenza tecnica, export)
Viale delle Industrie, 12 - 35010
Villafranca Padovana (PD)
P: 049.9070211 F: 049.9070504
E: hanna@hanna.it

Lucca

(Ufficio commerciale)
Via per Corte Capeccchi, 103 - 55100
Lucca (LU)
P: 0583.462122 F: 0583.471082
E: lucca@hanna.it

Ascoli Piceno

(Ufficio commerciale)
Via Dell'Airone, 27 - 63039 San
Benedetto del Tronto (AP)
P: 0735.753232 F: 0735.657584
E: ascolihanna.it

Salerno

(Ufficio commerciale)
S.S. 18 (Km 82,700) - 84025 S. Cecilia -
Eboli (SA)
P: 0828.601643 F: 0828.601658
E: salerno@hanna.it

Palermo

(Ufficio commerciale)
Via B. Mattarella, 58 - 90011
Bagheria (PA)
P: 091.906645 F: 091.909249
E: palermo@hanna.it

Cagliari

(Ufficio commerciale)
Via Parigi, 2 - 09032 Assemini (CA)
P: 070.947362 F: 070.9459038
E: cagliari@hanna.it

HANNA Nord Est Srl

Distributore per il
Nord Italia
Padova
Viale delle Industrie, 10 - 35010
Villafranca Padovana (PD)
P: 049.9070367 F: 049.9070488
padova@hanna.it

Milano

Via Privata Alzaia Trieste, 3 - 20090
Cesano Boscone (MI)
T: 02.45103537 F: 02.45109989
milano@hanna.it

Japan

HANNA instruments® Japan Co. Ltd
Chibaya-Bld. 1-8-8 Nihonbashi-
Murotsuchi
Chuo-Ku, Tokyo 103-0022 Japan
Japan
P: (03) 5205.3216
F: (03) 5205.3217
E: sales@hanna.co.jp
W: www.hanna.co.jp

Korea

HANNA Korea
Dongdaemun, P.O. Box 19
Seoul
Korea
P: 0502-013-2580
F: 0502-013-2581
E: mccoynhan@hannainst.co.kr
W: www.hannainst.co.kr

Malaysia

HANNA instruments® (M) Sdn Berhad
1. Jalan PJS 11 / 16
Bandar Sunway 46150
Petaling Jaya, Selangor Darul Ehsan
Malaysia
P: (603) 5638.9940 F: (603) 5638.9829
E: sales@hannainst.com.my

Mexico

HANNAPro S.A. de C.V.
Vainilla 462, Col. Granjas México,
08400
Mexico, D.F.
Mexico
P: +52 (55) 5649 1185
F: +52 (55) 5649 1186
E: hannapro@prodigy.net.mx
W: www.hannainst.com.mx

Morocco

HANNA instruments Morocco S.a.r.l.
Siège Social:
332, Bd Brahim Roudani - n° 12
Mañrif - CASABLANCA
Siège Opérationnel:
Av 11 Janvier - Bloc D1 n° 43,
Citè Ed-Dakhla - AGADIR
P: +212.(0)28.233530
+212.(0)28.233506
F: +212.(0)28.233517
W: www.hanna.ma

The Netherlands

HANNA instruments® BV
Lorentzlaan 17
3401 MX IJsselstein
The Netherlands
P: (31) 30.28.96.842
F: (31) 30.26.71.427
E: info@hannainst.nl
W: www.hannainst.nl

Poland

HANNA instruments® Poland
Al. J. Pilsudskiego, 73
10-449 Olsztyn
Poland
P: (89) 539.0961
F: (89) 539.0963
E: info@hanna.enet.pl

Portugal

HANNA instruments® Portugal
Instrumentos de Controle, Lda.
Rua de Manuel Dias, Fracção I
4495-129 Amorim - Povoia de varzim
Portugal
P: (252) 248670
F: (252) 248679
E: info@hannacom.pt
W: www.hannacom.pt

Romania

HANNA instruments® Romania srl
str. Republicii, 109
400489 Cluj-Napoca,
Romania
P: 0040 264.599.459
F: 0040 264.598.740
W: www.hanna.ro

Singapore

HANNA instruments® (S) Pte. Ltd
161, Kallang Way #07-12/14
Singapore, 349247
P: (65) 6296.7118
F: (65) 6291.6906

South Africa

HANNA instruments® (Pty) Ltd
6 Vernon Road
Morninghill, Bedfordview
Republic of South Africa
P: (011) 615.6076
F: (011) 615.8582
E: sales@hannainst.co.za
W: www.hannainst.co.za

Spain

HANNA instruments® S.L.
Pol. Industrial Aztain, Parcela 3B
Apartado Correos 379
20600 Eibar
Spain
P: (902) 420.100 / 420.103 (SAT)
F: (902) 420.101
E: marketing@hannaspain.com
W: www.hannainst.es

Taiwan

HANNA Trading Taiwan Pte. Ltd.
4F, No.106, Sec. 1, Yanping N. rd.
Taipei City 103
Taiwan R.O.C.
P: 886.2.2552.2041
F: 886.2.2552.2046

Thailand

HANNA instruments® (Thailand) Ltd
408/41 Phaholyothin Place Bldg
10th Floor Phaholyothin Road
Samsen-Nai Phayathai
Bangkok, 10400
Thailand
P: (662) 619.0708.11
F: (662) 619.0061
E: sales@hannathai.com
W: www.hannathai.com

United Kingdom

HANNA instruments® Ltd
Eden Way
Pages Industrial Park
Leighton Buzzard,
Bedfordshire LU7 4AD
England
P: (01525) 850.855
F: (01525) 853.668
E: salesteam@hannainst.co.uk
W: www.hannainst.co.uk

Vietnam

HANNA instruments® Vietnam
Room 3B 08 Saigon Trade Center
37 Ton Duc Thang Street
Ben Nghe Ward, Dist. 1
Ho Chi Minh City
Vietnam
P: (84.8) 9105478/ 79/ 80
F: (84.8) 9105477

P. 4	<p>ISE/pH Titration 4-8 Bench Meters 9-18 Portable Meters 19-26 Testers 27-29 pH and ORP Electrodes 30-45 ISE Electrodes 46-52 ISE Sensors and Accessories 53 ISE Solutions 54-55 pH and ORP Solutions 56-63 ORP, Refill, Cleaning and Storage Solutions 64 Turbidity, Salinity and Fluoride Solutions 65 Application Specific Cleaning Solutions 66</p>	P. 106	<p>Photometers Multiparameter Bench Meters 106-108 Multiparameter Portable Meters 109 Single Parameter Portable Meters 109-113 Standard Reagents 114 CAL CHECK™ Standard Reagents 115 Accessories 115</p>
P. 67	<p>Conductivity/TDS Bench Meters 67-71 Portable Meters 72-77 Testers 27-29 Solutions 78</p>	P. 116	<p>Thermometers Portable Meters 116-119 Dataloggers 120 T-Logger 121 Testers 122</p>
P. 79	<p>Multiparameter Bench Meters 79-81 Portable Meters 82-86 Testers 27-29</p>	P. 123	<p>Warranty</p>
P. 87	<p>Dissolved Oxygen Bench Meters 87-88 Portable Meters 89-90</p>		
P. 91	<p>Turbidity Bench Meters 91-94 Portable Meters 95-99</p>		
P. 100	<p>COD Bench Meters 100-103 Certified Reagents 104 Test Kit 105 Test Tube Heater 105</p>		



P. 9

HI 901 • HI 902

Automatic Titration Systems

with Clip-Lock™ Exchangeable Burette System and Automatic Burette Recognition



Clip-Lock™ Exchangeable Burette System

With Clip-Lock™, it only takes a couple of seconds to exchange the reagent burettes to perform a different titration.

With conventional titrators, there is the risk of cross contamination of titrants when exchanging reagents. Reconfiguring the titrator for different sample methods consumes time and reagents. Each method may need different reagents and care must be used when purging and cleaning the burette. To avoid these problems, HANNA introduces the Clip-Lock™ exchangeable burette system to prevent cross contamination while reducing loss of time and reagents. Burettes simply slide out for quick exchanges and detaching the aspiration and dispensing tubes from the titrant bottles is easy.

Having several prepared burettes on hand will make the HANNA 900 series the fastest and most versatile titration systems available. Interrupting an important cycle of analysis due to a malfunctioning burette is a thing of the past. With the HANNA Clip-Lock™ system you can simply substitute the burette and complete all your tests with the same titrant!

HANNA's burettes feature a threaded screw connection to prevent leakage problems. Burettes are available in 5 mL, 10 mL & 25 mL sizes and are made of chemically resistant material to ensure many years of trouble-free operation.



Automatic Titration Systems

with Clip-Lock™ Exchangeable Burette System and Automatic Burette Recognition

Powerful Customization, Accurate Analysis

HI 901 and HI 902 are automatic titrators from HANNA that compliment our wide range of products dedicated to quick and accurate laboratory analysis. HI 902 also features the addition of back-titration capabilities.

Each unit is provided with a host of numerous features suitable for routine sample analysis. HI 901 and HI 902 perform acid/base, potentiometric and amperometric titrations.

With our exclusive Clip Lock™ system for burette replacement, changing from one titrant to another is done in a flash! Often, preliminary titration operations are very long and arduous. A burette often needs to be adjusted for correct dosing, which extends waiting time for new sample analysis. HANNA has engineered a way to solve this problem.

The innovative Clip Lock™ system allows users to change burettes in two simple steps, passing from one titrant to the next



Automatic Burette Volume Recognition

This feature makes exchanging titrants convenient, safe and fast.

Up to 100 reports of analysis, complete with titration curve graphing is possible. A calibration "time-out" can be set and the user can be advised when the pH electrode needs to be calibrated. The instrument's status can be viewed clearly on the large LCD screen. Contained in the set-up menu, features like language, display brightness, resolution, pH electrode calibration, date and hour can be adjusted. During analysis, the titration is displayed in real-time together with the stored data. Date, hour, temperature (when probe is connected) and warning messages such as a pH electrode calibration message can all be displayed for your convenience.



Stirrer

The optional stirrer ensures an effective mixing with a selectable speed from 100 to 2500 rpm.

These versatile titrators support up to 10,000 methods: standard or user defined. When powered on, the instrument initiates an internal diagnostics check and then readies itself for the first titration of the day. A large LCD screen clearly shows the chosen method, correlated information and also indicates which parameters may be adjusted. A real-time titration curve is shown on the display; this feature is useful when new methods are tested or when a procedure needs to be optimized. At the end of the titration, all data, including the graph, are automatically stored in memory and can be copied to disk via the built-in floppy drive or through direct connection with the serial cable supplied with the titrator. The titrators are equipped with an RS485 serial port.

Burette maintenance is simple and completely automated. The user can decide to purge it or wash it and can select how many washings to perform.

without any problem. Additionally, HI 901 and HI 902 automatically recognizes the volume of the new burette.

Both HI 901 and HI 902 can drive two pumps, with the HI 902 incorporating a more advanced system. While the HI 901 can drive the two pumps separately, HI 902 can also drive them concurrently and perform back titrations. HI 902 can perform more complex functions with the ability to determine more than one equivalence point.

Users can connect pH or ORP electrodes to this unit, as well as create a complete workstation with a PC, monitor, keyboard and printer. This unit complies with GLP specifications, providing validation support for analysis. All GLP information from each sample can be stored, including ID number, date and time of analysis, electrode ID code and last calibration date.

Quick Change

Keep several burettes on hand for a quick change.



HI 901 • HI 902

Automatic Titration Systems

with Clip-Lock™ Exchangeable Burette System and Automatic Burette Recognition

Keep an accurate record of analyses!

HANNA's 900 Series titration systems are easily incorporated into any existing GLP data management program:

- Users can easily record all necessary GLP information with every sample including sample identification, company and operator name, date, time, electrode ID codes and calibration information.
- Data can also be transferred using the integral floppy disk drive for communication with a PC or even other titration systems. Special memory cards are not required.
- All test results can be transferred directly to a PC.
- Users can print reports of analyses directly from the titrator using a standard parallel printer.
- An external monitor and keyboard can be attached for added versatility.
- RS485 port for future expansion.



Custom methods

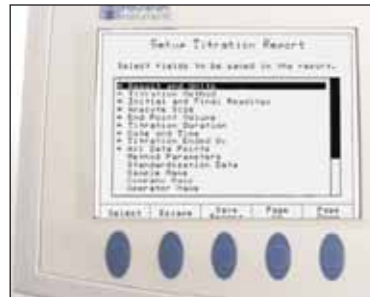

Record up to 100 reports



Incorporate HANNA 900 series titrators into any GLP data management program

View Store Print

with HANNA PC Connectivity



PC Connectivity

The HI 900 series titrators can be connected to a computer in conjunction with HANNA software.



VGA Display Connectivity

The information shown on the titrator display can be viewed on a standard VGA display via a 15-pin socket.



Printer Connectivity

The HI 900 series titrators accept a variety of parallel printers for printing of data.



PC Keyboard Connectivity

An external PC compatible keyboard can be connected.

A Complete Analysis

These instruments perform a complete analysis comprising of sample preparation, dispensing of titrant solution, stirring, measuring and waiting times, recognition of the end point and storing the results. All the parameters that a titration requires are grouped into a method.

The titrators are already supplied with a set of standard methods or you can create your own. Using a floppy disk or connecting the titrator to the HI 900 PC application, methods (standard and user) can be upgraded, stored or deleted.

HI 901 and HI 902 Automatic Titrators Feature:

- 320 x 240 pixel LCD w/backlight
- Precise dosing system (accuracy under 0.1% of burette volume)
- Supports up to 10,000 titration methods (standard and user defined)
- Clip Lock™ — change burettes quickly with auto burette recognition
- Dynamic/Linear dosing feature
- Fixed end point potential or pH
- Equivalence point detection (first derivative and second derivative)
- The results are displayed directly in the selected units
- Titration graph can be displayed on-screen and saved
- User customized reports can be printed, saved on floppy disk or transferred to PC via RS232 interface
- Reminders for titrant age and standardization expiration
- Self diagnostic features for peripheral devices including pump, valve, burette and stirrer



- | | | | |
|--|--------------------------------------|-----------------------------|---------------------------------------|
| A. Aspiration Tube (Titrant Inlet) | F. Support Bar | K. Stirrer Propeller | P. Arrow Keys |
| B. Dispensing Tube (Titrant Outlet) | G. Sliding Positioning Collar | L. Stirrer Stand | Q. Option Keys |
| C. Burette Assembly | H. Dispensing Tip | M. Numeric Keys | R. 320 x 240 Pixel Graphic LCD |
| D. Light Shield (in closed state) | I. Temperature Sensor | N. Function Keys | |
| E. Burette Support | J. pH Electrode | O. Help Key | |

HI 901 • HI 902

Automatic Titration Systems

with Clip-Lock™ Exchangeable Burette System and Automatic Burette Recognition

SPECIFICATIONS	mV	pH	Temperature
Range	-2000.0 to 2000.0 mV	-2.000 to 20.000 pH	-5.0 to 105.0°C/23 to 221°F/268.2 to 378.2 K
Resolution	0.1 mV	0.1/0.01/0.001 pH	0.1°C/0.1°F/0.1K
Accuracy	±0.1 mV (@25°C/77°F)	±0.001 pH (@25°C/77°F)	±0.1°C/±0.2°F/±0.1K (excluding probe error)
Burette Sizes	5, 10, and 25 mL		
Burette Resolution	1/40000		
Display Resolution	0.001 mL		
Dosing Accuracy	±0.1% of full burette volume		
Display	Graphic LCD, 320 x 240 pixel LCD		
Languages	English, Italian, Portuguese, Spanish		
Methods	Up to 10,000 methods (standard and user-defined)		
Burette Auto-Detection	Burette size is automatically recognized when inserted into the unit		
Programmable Stirrer	Propeller type, 100-2500 RPM, automatically held within 10% of the set value, resolution 100 rpm		
Flow Rate	User-selectable from 0.1 mL/min to 2 x burette volumes/min		
pH/mV Measurement	Titrators can also perform direct pH and mV measurements		
Temperature Compensation	Manual or automatic (ATC)		
pH Calibration	Manual or automatic at 1-5 points with 4 buffer sets or custom buffers		
Potentiometric Titrations	Acid-Base (pH or mV-Mode), Redox, Precipitation, Complexometric, Non-Aqueous, Ion-Selective, Argentometric (in mV-mode only)		
HI 901 Titration Methods	Fixed mV or pH end-point detection & first equivalency point detection (with the 1st or 2nd derivatives)		
HI 902 Titration Methods	Fixed mV or pH end-point detection & multiple equivalency point detection (with the 1st or 2nd derivatives); back titration		
Measurement Units	User specified expression of concentration units to suit specific calculation requirements		
Real Time & Stored Graphs	mV-Volume or pH-Volume titration curve, 1st derivative curve or 2nd derivative curve, in pH-mode or mV-mode; pH/mV values versus time-datalogging results		
Data Storage:	Up to 100 complete titration and pH/mV logging complete reports		
Disk Drive:	Built-in 3.5" floppy disk drive allows storage and transfer of configurations, preprogrammed methods, custom methods, titration reports and bitmap graph files		
Peripherals	Connections for VGA display, PC-keyboard, parallel printer, RS 232 input, interface for future expansion		
GLP Conformity	Instrumentation data storage and printing capabilities		
Operating Environment	10 to 40°C (50 to 104°F), up to 95% RH		
Storage Environment	-20 to 70°C (-4 to 158°F), up to 95% RH		
Power	110V/220 Vac; 50-60Hz		
Dimensions	Width x Depth x Height = 390 x 350 x 380 mm (15.3 x 13.8 x 14.9 in)		
Weight	approx. 10 kg (22 lbs.) with one pump and stirrer assembly		

ORDERING INFORMATION

HI 901-01 (115V) and **HI 901-02** (230V) is supplied with (1) 25 mL glass burette, (1) burette driver assembly, power adapter and instructions.

HI 902-01 (115V) and **HI 902-02** (230V) back titration and multiple end-point titrators are supplied with (1) 25 mL glass burette, (1) burette driver assembly, power adapter and instructions.



HI 4522 • HI 4521 • HI 4222 • HI 4221
Research Grade pH Meters
with Color Display

ISE/pH
Bench Meters

Key Features

- 240 x 320 Color Display
- Simultaneous dual graph display and real-time logging
- USB and RS232 for Computer Compatibility
- Multi-language interface
- GLP data
- Manual or automatic temperature compensation
- Relative mV scale
- Small footprint
- Menu screens are informative and navigation is intuitive
- Electrode holder (included) holds 3 electrodes and screws securely into the base of the Research Grade Meter series

pH Features

- Exclusive Calibration Check™
- 5 point calibration with standard and custom buffers

ISE Features

- Direct calibration and measurement in multiple units
- Incremental methods: Known addition, Known subtraction, Analyte addition, Analyte subtraction

EC Features

- EC, resistivity, TDS and salinity ranges
- Auto recognition of probe type (2 or 4 ring, and nominal cell constant)
- Extended range from 0.001 $\mu\text{S}/\text{cm}$ to 1 mS/cm
- Stages 1, 2 and 3 USP mode
- 3 salinity scales: Practical salinity, Natural sea water and Percent
- Linear and natural water temperature compensation



Research Grade, Professional Benchtop Instruments

HANNA's new family of research grade laboratory benchtop instruments feature a 240 x 320 dot-matrix color display with on-screen help, simultaneous graphing, language selection and custom configuration.

HANNA's research grade pH meters feature a 5 point calibration with a choice of custom or standard buffers and provide the user with the exclusive Calibration Check™ diagnostic system. ISE models allow direct calibration and measurement with a choice of units as well as incremental methods.

Our new HI 4522 and HI 4521 pH/EC meters feature resistivity, TDS and salinity measuring scales in addition to pH and EC. EC has an extended range from 0.001 $\mu\text{S}/\text{cm}$ to 1 mS/cm with auto recognition of the probe type used. Salinity measurements can be displayed in practical salinity, natural sea water or in percent scale.

Models that incorporate conductivity measurement (including HI 4321 in our conductivity section) feature USP modes for stage 1, 2 or 3. Linear and natural water temperature compensation are also available.

All models are equipped with USB and RS232 ports for PC connectivity and offer logging, graphing and GLP capabilities.

The two measurement channels of the HI 4522, HI 4521 and HI 4222 are galvanically isolated to eliminate noise and instability. In ISE mode, these instruments provide the user with a choice of several incremental methods. Communication is via opto-isolated USB and RS232 ports.



HI 4522 • HI 4521 • HI 4222 • HI 4221

Research Grade pH Meters

with Color Display

pH Calibration Check™

Proper calibration of both the pH meter and pH electrode system is critical in order to achieve reliable results. HANNA's exclusive Calibration Check™ system includes several features to help users reach that goal.

- Each time a pH calibration is performed, the instrument compares the new calibration with the previous one. When this comparison indicates a significant difference, the message alerts the user to either clean the electrode, check the buffer or both.
- When measurements are taken too far from the calibration points, the instrument will warn the user with a message on the LCD.
- The condition of the pH electrode after calibration is shown on the display to track aging.
- To avoid taking readings with old calibrations, the instrument automatically reminds the user when the calibration has expired.



ISE Incremental Methods

Ion concentration determinations with ISE's can be made faster and easier using the streamlined Incremental Methods.

Incremental methods involve adding a standard to a sample, or sample to a standard. A mV change occurs due to the addition. Historically the user would then use mathematical equations to determine the ion concentration of the sample; but with the HI 4522, HI 4521 and HI 4222, sample concentrations are calculated automatically and then logged into an ISE method report. 200 reports can be saved for future recall.



Incremental Method techniques can reduce errors from variables such as temperature, viscosity, pH or ionic strength. The electrodes remain immersed throughout the process thus reducing measurement time as well as eliminating sample carry over and its associated errors. Known Addition, Known Subtraction, Analyte Addition, and Analyte Subtraction methods are standard method choices provided.

EC USP Mode

HANNA's HI 4522 and HI 4521 can be used to perform all 3 stages of United States Pharmacopeia testing requirements for water quality (USP <645>).

The instruments give clear instructions on how to perform each stage and automatically check that the temperature, conductivity and stability are within USP limits.

Comprehensive results are shown for all stages on a single screen at the end of the test. Up to 200 reports can be saved for future recall.



HI 4522 • HI 4521 • HI 4222 • HI 4221
Research Grade pH Meters
with Color Display

Incremental Method Analysis Example

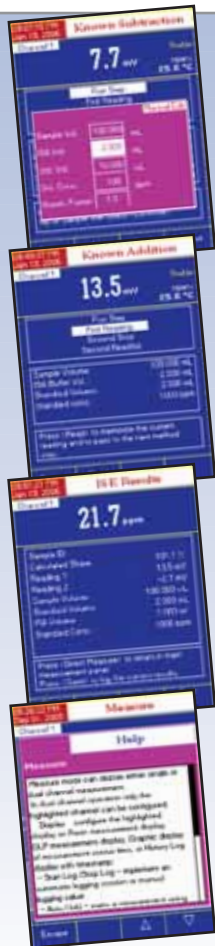

First Step

The first step in performing an incremental method analysis is to enter the required parameters including sample, ISA and standard volumes and standard concentration.

When repeating the analysis on another sample, the parameters do not need to be reentered.

Sequence of Readings

Once the variables are entered, the user is guided step-by-step through the measurement.

The initial mV measurement is made before the addition, next is the addition, and then the second measurement is made.

Results

The results are automatically calculated and shown together with all the parameters used.

At this time, results can be saved into an ISE Methods Report (if necessary, the user can edit the parameters without having to redo the entire analysis). Multiple samples analysis is enabled without having to reenter set-up data.

Contextual Help Screen

Users can consult the on-screen help from any mode simply by pressing the HELP key.

The instrument will then display the meaning and options available of the current screen.



L C D Display
E x a m p l e s

Dual Channel Display



Real Time Logging



Simultaneous Dual-channel Graphing



Calibration Data shown for both channels



ORDERING INFORMATION

HI 4221-01 (115V) and **HI 4221-02** (230V) are supplied with glass body pH electrode, temperature probe, power adapter, pH 4 and pH 7 buffer solutions, electrode refilling solution, electrode holder and instructions.

HI 4222-01 (115V) and **HI 4222-02** (230V) are supplied with glass body pH electrode, temperature probe, power adapter, pH 4 and pH 7 buffer solutions, electrode refilling solution, electrode holder and instructions.

HI 4521-01 (115V) and **HI 4521-02** (230V) are supplied with 4-ring EC probe, glass body pH electrode, temperature probe, power adapter, pH 4 and pH 7 buffer solutions, electrode refilling solution, electrode holder and instructions.

HI 4522-01 (115V) and **HI 4522-02** (230V) are supplied with 4-ring EC probe, glass body pH electrode, temperature probe, power adapter, pH 4 and pH 7 buffer solutions, electrode refilling solution, electrode holder and instructions.

ELECTRODES

HI 1131B Refillable pH electrode with BNC connector and 1m (3.3') cable

HI 7669/2W Temperature probe

SOLUTIONS

HI 5004 pH 4.01 buffer solution, 500 mL

HI 5007 pH 7.01 buffer solution, 500 mL

HI 5010 pH 10.01 buffer solution, 500 mL

HI 54710 pH 4.01, pH 7.01 and pH 10.01 buffer solution, 500 mL ea.

HI 70300L Electrode storage solution, 500 mL

HI 7061L Electrode cleaning solution, 500 mL

ACCESSORIES

HI 76404N Electrode holder

HI 92000 Windows® compatible software

HI 920010 RS232 cable for PC connection

HI 920013 USB cable for PC connection

HI 180G* Compact magnetic stirrer with ABS plastic cover, max 1000 rpm, Speedsafe™

HI 190M* Magnetic stirrer with ABS plastic cover max 1000 rpm, Speedsafe™

HI 200M* Magnetic stirrer with AISI stainless steel cover, max 1000 rpm, Speedsafe™

* -1: 110/115V, 50/60Hz -2: 220/240V, 50/60Hz

HI 4522 • HI 4521 • HI 4222 • HI 4221

Research Grade pH Meters

with Color Display



SPECIFICATIONS		HI 4522	HI 4521	HI 4222	HI 4221
pH	Range	-2.0 to 20.0; -2.00 to 20.00; -2.000 to 20.000 pH			
	Resolution	0.1 pH; 0.01 pH; 0.001 pH			
	Accuracy	±0.1 pH; ±0.01 pH; ±0.002 pH			
mV	Range	±2000 mV			
	Resolution	0.1 mV			
	Accuracy	±0.2 mV			
ISE	Range	1 x 10 ⁻⁷ to 9.99 x 10 ⁻¹⁰ concentration ±0.2 mV	—	1 x 10 ⁻⁷ to 9.99 x 10 ⁻¹⁰ concentration ±0.2 mV	—
	Resolution	1; 0.1; 0.01 concentration	—	1; 0.1; 0.01 concentration	—
	Accuracy	±0.5% (monovalent ions); ±1% (divalent ions)	—	±0.5% (monovalent ions); ±1% (divalent ions)	—
Conductivity	Range	0.000 to 9.999 µS/cm; 10.00 to 99.99 µS/cm; 100.0 to 999.9 µS/cm; 1.000 to 9.999 mS/cm; 10.00 to 99.99 mS/cm; 100.0 to 999.9 mS/cm; 1000 mS/cm			—
	Resolution	0.001 µS/cm; 0.01 µS/cm; 0.1 µS/cm; 0.001 mS/cm; 0.01 mS/cm; 0.1 mS/cm; 1 mS/cm			—
	Accuracy	±1% of reading (±0.01 µS/cm)			
Resistivity	Range	1.00 to 99.99 Ohm·cm; 100.0 to 999.9 Ohm·cm; 1.000 to 9.999 kOhm·cm; 10.00 to 99.99 kOhm·cm; 100.0 to 999.9 kOhm·cm; 1.00 to 9.99 MOhm·cm; 10.0 to 100.0 MOhm·cm			—
	Resolution	0.01 Ohm·cm; 0.1 Ohm·cm; 0.001 kOhm·cm; 0.01 kOhm·cm; 0.1 kOhm·cm; 0.01 MOhm·cm; 0.1 MOhm·cm			—
	Accuracy	±2% of reading (±1 Ohm·cm)			
TDS	Range	0.000 to 9.999 ppm; 10.00 to 99.99 ppm; 100.0 to 999.9 ppm; 1.000 to 9.999 ppt; 10.00 to 99.99 ppt; 100.0 to 400.0 ppt			—
	Resolution	0.001 ppm; 0.01 ppm; 0.1 ppm; 0.001 ppt; 0.01 ppt; 0.1 ppt			
	Accuracy	±1% of reading (±0.01 ppm)			
	Factor	0.40 to 1.00			
Salinity	Range	Practical salinity: 0.00 to 42.00; Natural seawater: 0.00 to 80.00 ppt; Percent: 0.0 to 400.0%			—
	Resolution	0.01 for practical salinity/natural sea water; 0.1% for percent scale			
	Accuracy	±1% of reading			
Temperature	Range	-20.0 to 120.0°C; -4.0 to 248.0°F; 253.15 to 393.15K			
	Resolution	0.1°C; 0.1°F; 0.1K			
	Accuracy	±0.2°C; ±0.4°F; ±0.2K			
Calibration	pH	Automatic, Up to five-point calibration, 8 standard buffers available (1.68, 3.00, 4.01, 6.86, 7.01, 9.18, 10.01, 12.45), and 5 custom buffers			
	ISE	Automatic, Up to 5 point calibration, 5 fixed standard solutions available for each measurement unit, and 5 custom solutions	—	Automatic, Up to 5 point calibration, 5 fixed standard solutions available for each measurement unit, and 5 custom solutions	—
	Conductivity	Auto standard recognition, custom calibration solution/4 point calibration		—	
	Salinity	Percent scale—1 point (with HI 7037 solution)		—	
	Temperature	3 points			
Relative mV Offset Range	±2000 mV				
Input Channel(s)	1 pH/mV /ISE + 1 EC	1 pH/mV + 1 EC	2 pH/mV/ISE	1 pH/mV	
Calibration Check™	pH electrode and buffer condition				
Temperature Compensation	pH: Automatic or manual from -20.0 to 120.0°C (-4.0 to 248.0°F); EC: Linear and non-linear (natural water)				
Log-on-demand	100 Lots, 5000 samples per lot				
Logging Intervals	1, 2, 5, 10, 30 sec				
Auto Endpoint	Yes				
PC Connection	Opto-isolated USB and RS232				
Display	240 x 320 dot-matrix color LCD with on-screen help, graphing, language selection and custom configuration				
Power	12 Vdc adapter (included)				
Dimensions/Weight	160 x 231 x 94 mm (6.3 x 9.1 x 3.7")/800 g (1.8 lbs.)				



HI 221 • HI 223

Calibration Check™ pH Meters

with Logging of up to 500 Samples

ISE/pH
Bench Meters

Key Features

- Logging up to 500 samples
- Last calibration data
- Instrument ID number
- Real time clock
- PC interface
- Low profile and takes little bench space



GLP

In addition to storing calibration data, the instruments can be programmed to give an alarm when a new calibration is required.

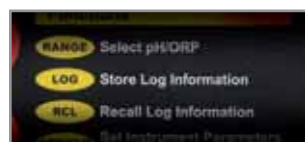

Log-On-Demand

Both instruments have a "Log-On-Demand" function to record 100 (HI 221) or 500 (HI 223) readings.



Recall

Readings logged with the HI 221 & HI 223 can be recalled at a later time.

Figure A

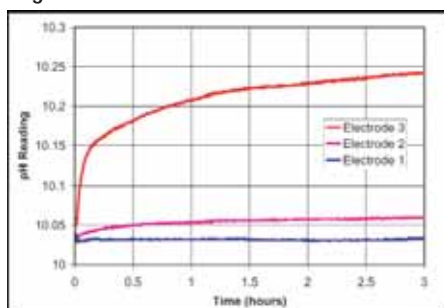

Electrode 1 was properly cleaned prior to calibration.
Electrodes 2 and 3 were not.

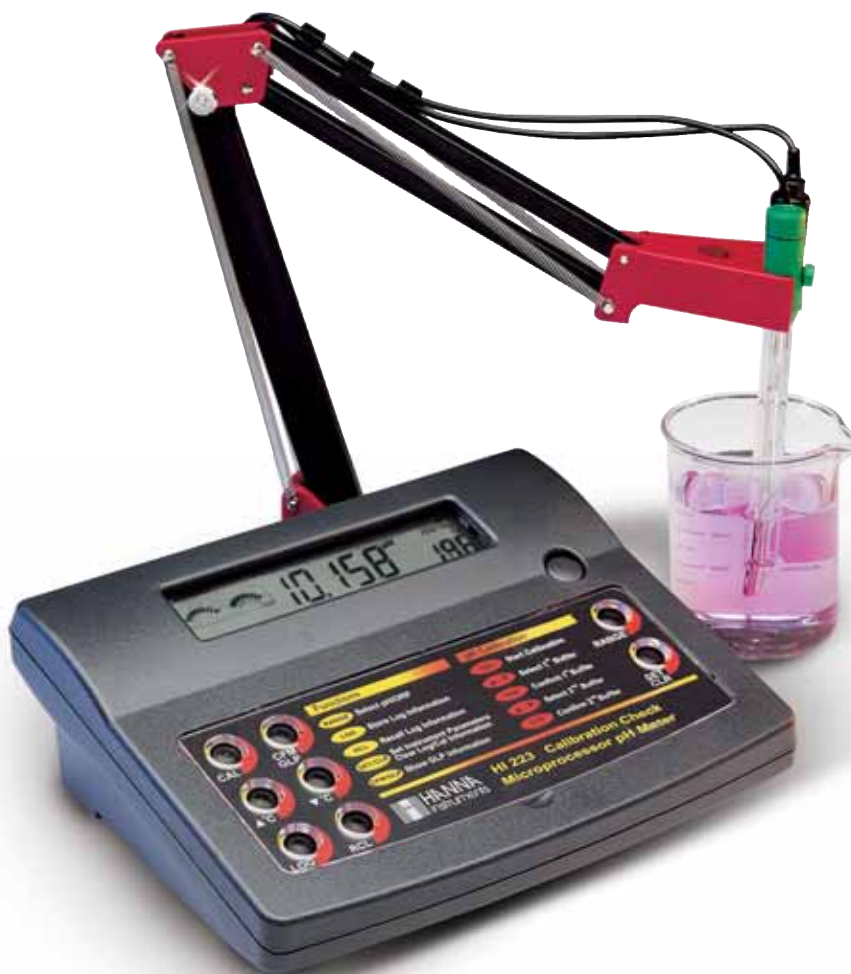

Electrode Monitoring in a Bench Meter

A pH electrode that is properly manufactured and kept clean will retain its measuring integrity for a long time. As a result of many factors such as age, poor maintenance or improper handling, any electrode in time will lose integrity. HI 221 and HI 223 are created to alert the user if an electrodes integrity has been compromised.

The most common cause for pH measurement inaccuracies is an unclean or improperly cleaned electrode. This is very important to note because, during calibration, the instrument assumes that the electrode is clean and that the standardization curve created during the calibration process will remain a valid reference until the next calibration. pH meters on the market today will allow an offset of approximately ± 60 mV. The deviation from 0 mV is not unusual, in fact it represents the true characteristics of the pH electrode. The deviation from 0 mV becomes a problem if it is the result of calibrating a dirty electrode.

HANNA HI 221 & HI 223 compare the characteristics of the pH electrode from one calibration to the next. In the case of large variances in the electrode condition that can only be the result of a soiled sensor, these meters alert the user that the electrode needs to be properly cleaned prior to calibration and measuring.

Figure A (right) shows that the pH measured by a dirty electrode changes over a short period of time. This results from the residue on the pH electrode bulb dissolving into the solution and the electrode gradually returning close to its true characteristics. The resulting pH measurements, based upon the calibration of a dirty electrode, will then be incorrect.

HI 221 • HI 223

Calibration Check™ pH Meters

with Logging of up to 500 Samples



How Calibration Check™ Works

For Solutions

HI 221 and HI 223 are able to detect if the calibration buffer solution is contaminated.



For Electrodes

When a pH electrode is dirty, it has a slow response time & unstable reading. HI 221 and HI 223 warn the user in the event a dirty electrode has been used.



Calibration Check™ Features

- Enhanced Calibration Messages**
 During calibration, the user is warned if one or more parameters are not suitable to perform an accurate calibration.
- Electrode Condition on LCD Display**
 Determined from the electrode offset and slope.
- Electrode Response Time on LCD Display**
 Determined from electrode performance during calibration.
- Calibration Alarm Time Out**
 Can be programmed from 1 to 7 days or can be disabled.

SPECIFICATIONS		HI 221	HI 223
Range	pH	-2.00 to 16.00	-2.00 to 16.00; -2.000 to 16.000
	mV	±699.9 mV; ±2000 mV	±999.9 mV; ±2000 mV
	Temperature	-20.0 to 120.0°C	
Resolution	pH	0.01	0.01; 0.001
	mV	0.1 (±699.9 mV); 1 (±2000 mV)	0.1 (±999.9 mV); 1 (±2000 mV)
	Temperature	0.1°C	
Accuracy	pH	±0.01	±0.01; ±0.002
	mV	±0.2 (±699.9 mV); ±1 (±2000mV)	±0.2 (±699.9 mV); ±0.5 (±999.9 mV); ±1 (±2000mV)
	Temperature	±0.4°C	
Calibration Check™		Status of electrode condition and response time; status of the buffer solutions during calibration	
pH Calibration		automatic, 1 or 2 point with 7 memorized values (pH 1.68, 4.01, 6.86, 7.01, 9.18, 10.01, 12.45)	
Temperature Compensation		manual or automatic, -20.0 to 120.0°C (-4 to 248°F)	
pH Electrode		HI 1131P glass-body, single junction, refillable, BNC + pin (included)	
Temperature Probe		HI 7669/2W stainless steel temperature probe (included)	
PC Connection		RS232 opto-isolated serial port	
Data Logging		100 points	500 points
Input Impedance		10 ¹² Ohm	
Power Supply		12 Vdc adapter (included)	
Environment		0 to 50°C (32 to 122°F); RH max 95%	
Dimensions / Weight		240 x 182 x 74 mm (9.4 x 7.2 x 2.9") / 1.1 kg (2.4 lbs.)	

ORDERING INFORMATION

HI 221* and HI 223* are supplied with HI 1131P glass-body combination pH electrode with 1m (3.3") cable, HI 7669/2w temperature probe, HI 76404 electrode holder, pH 4.01 & 7.01 Buffer solutions (20 mL), HI 7071S electrolyte solution, 12 Vdc power adapter and instruction manual.

ELECTRODES

Combination pH electrodes. All part codes ending with P are provided with BNC & Pin connectors, and 1 m (3.3') cable.

- HI 1043P** Use: strong acids and bases. Glass-body, double junction, refillable
- HI 1053P** Use: emulsions. Glass-body, triple ceramic junction, refillable
- HI 1083P** Use: biotechnology. Glass-body, open junction, refillable

- HI 1131P** Use: general purpose. Glass-body, ceramic junction, refillable
- HI 1332P** Use: general purpose. PEI body, double junction, refillable

SOLUTIONS

- HI 5004** pH 4.01 buffer solution, 500 mL
- HI 5007** pH 7.01 buffer solution, 500 mL
- HI 5010** pH 10.01 buffer solution, 500 mL
- HI 54710** pH 4.01, pH 7.01 and pH 10.01 buffer solution, 500 mL ea.
- HI 70300L** Electrode storage solution, 500 mL
- HI 7061L** Electrode cleaning solution, 500 mL

ACCESSORIES

- HI 920010** RS232 cable for PC connection
- HI 92000** Windows® compatible software



HI 92000 — Windows® Compatible Software

* Supplied with 115V (add -1) or (add -2) 230V power supply



HI 250 • HI 251 • HI 253 • HI 254 pH/ISE Professional Meters

for Laboratory Workflows

ISE/pH
Bench Meters

pH/ISE Bench Meters Designed for Busy Lab Workflows

These new pH/ORP bench meters are ideal for accurate and precise measurements for all laboratory needs.

HI 253 can perform ion-selective measurements directly in ppm, as well as pH, ORP and temperature measurements.

A 5 point calibration can be made on the HI 254 by selecting from the 7 auto recognized standard pH buffers thus providing an extremely accurate calibration curve for difficult samples.

HI 250 and HI 251 are next generation pH meters that combine high technology and affordability with advanced new features. Both instruments can measure pH with centesimal resolution.

All of these meters can store up to 50 data sets in “non-volatile memory” that can be downloaded to a PC. These instruments incorporate GLP features so the user can recall calibration data at any time.



- Up to 5 point calibration
- Custom buffers
- GLP functions

Specifications		HI 250	HI 251	HI 253	HI 254
Range	pH	-2.0 to 16.0 pH; -2.00 to 16.00 pH		-2.0 to 16.0 pH; -2.00 to 16.00 pH; -2.000 to 16.000 pH	
	mV	—	±699.9 mV; ±2000 mV	±699.9 mV; ±2000 mV	
	Selective Ions	—	—	0.001 to 19999 ppm	—
	Temperature	-9.9 to 120.0°C		-9.9 to 120.0°C	
Resolution	pH	0.1 pH; 0.01 pH		0.1 pH; ±0.01 pH; 0.001 pH	
	mV	—	0.1 mV (±699.9 mV); 1 mV (±2000 mV)	0.1 mV (±699.9 mV); 1 mV (±2000 mV)	
	Selective Ions	—	—	0.001 (0.001 to 9.999) ppm 0.01 (10 to 99.99) ppm 0.1 (100 to 999.9) ppm 1 (1000 to 19999) ppm	—
	Temperature	0.1°C		0.1°C	
Accuracy (@20°C)	pH	±0.1 pH; ±0.01 pH		±0.1 pH; ±0.01 pH; ±0.002 pH	
	mV	—	±0.2 mV (±699.9 mV); ±1 mV (±2000 mV)	±0.2 mV (±699.9 mV); ±1 mV (±2000 mV)	
	Selective Ions	—	—	±0.5%	—
	Temperature	±0.4°C (excluding probe error)		±0.4°C (excluding probe error)	
Relative mV Offset	—	± 2000 mV	± 2000 mV		
pH Calibration	automatic, 1, 2 or 3 point with 5 memorized values (pH 4.01, 6.86, 7.01, 9.18, 10.01)			automatic, 1, 2, 3, 4 or 5 point with 7 memorized buffers (pH 1.68, 4.01, 6.86, 7.01, 9.18, 10.01, 12.45)	
ISE Calibration	—	—	automatic, 1 or 2 point (0.1, 1, 10, 100, 1000 ppm)	—	
Temperature Compensation	automatic (with HI 7669/2W probe) or manual from -9.9 to 120°C				
pH Electrode	HI 1131B, glass-body, double junction, refillable, BNC connector, 1 m cable (included)				
Temperature Probe	HI 7669/2W with 1 m (3.3') cable (included)				
Input Impedance	10 ¹² Ohm				
PC Connection	RS232 opto-isolated serial port				
Power Supply	12 Vdc adapter (included)				
Environment	0 to 50°C (32 to 122°F); RH max 95%				
Dimensions / Weight	240 x 182 x 74 mm (9.4 x 7.2 x 2.9") / 1.1 kg (2.4 lbs.)				

ORDERING INFORMATION

HI 250*, **HI 251***, **HI 253*** and **HI 254*** are supplied with HI 1131B glass-body combination pH electrode with 1 m (3.3') cable, HI 7669/2W temperature probe, HI 76404 electrode holder, pH 4.01 & 7.01 buffer solutions (20 mL ea.), HI 7071S electrolyte solution, 12Vdc power adapter and instruction manual.

* Supplied with 115V (add **-1**) or (add **-2**) 230V power supply

ELECTRODES

HI 1131B Refillable pH electrode with BNC connector with 1m (3.3') cable

HI 7669/2W Temperature probe

SOLUTIONS

HI 5004 pH 4.01 buffer solution, 500 mL

HI 5007 pH 7.01 buffer solution, 500 mL

HI 5010 pH 10.01 buffer solution, 500 mL

HI 54710 pH 4.01, pH 7.01 and pH 10.01 buffer solution, 500 mL ea.

HI 70300L Electrode storage solution, 500 mL

HI 7061L Electrode cleaning solution, 500 mL

ACCESSORIES

HI 76404 Electrode holder

HI 92000 Windows® compatible software

HI 920010 RS232 cable for PC connection

HI 710005 115 Vac/12 Vdc pwr adapter (US)

HI 710006 230 Vac/12 Vdc pwr adapter (EU)

HI 110 Series

High Precision pH Meters

for Professional Laboratories



- Up to 5 point calibration (HI 112 and HI 113)
- Custom buffers or 7 standard pH buffers
- GLP functions

For Challenging Applications

HI 112 and HI 113 are designed for those users that require the highest level of precision over the entire pH range. These meters are ideal for the most challenging applications where the sample pH may vary greatly. Depending on the level of precision required for each application, the user can select the pH resolution as 0.01 or 0.001.

A 5 point calibration may be performed on these meters. Choose the most suitable buffers for your system from the 7 standard buffers. If the memorized buffer values are not the most ideal for your application, HI 112 and HI 113 will allow you to manually set 2 custom pH values for calibration.

HI 110 and HI 111, are ideal for those users that need a higher level of precision in certain pH ranges. Automatic pH calibration can be performed at 3 points, by choosing the most suitable buffers from the 5 buffer values. HI 110 and HI 111 will also allow users to manually set 2 custom pH values for calibration most appropriate to you application range.

The HI 111 and 113 take mV measurements while HI 112 and HI 113 support RS232 computer connection. Data can be transferred with the HI 92000 application software.

The HI 110 Series features an extended temperature range (from -9.9 to 120°C), GLP functions, manual or automatic temperature compensation and custom buffers.

SPECIFICATIONS		HI 110	HI 111	HI 112	HI 113
Range	pH	-2.00 to 16.00 pH		-2.00 to 16.00; -2.000 to 16.000 pH	
	mV	—	±699.9 mV, ±2000 mV	—	±999.9 mV, ±2000 mV
	Temperature	-9.9 to 120.0°C			
Resolution	pH	0.01 pH		0.01 pH; 0.001 pH	
	mV	—	0.1mV; 1 mV	—	0.1mV; 1 mV
	Temperature	0.1°C			
Accuracy (@20°C)	pH	±0.01 pH		±0.01 pH; ±0.002 pH	
	mV	—	±0.2 mV; ±1 mV	—	±0.5 mV; ±1mV
	Temperature	±0.4°C			
Relative mV Offset		—	±2000 mV	—	±2000 mV
pH Calibration		automatic, up to 3 points with 5 memorized values (pH 4.01, 6.86, 7.01, 9.18, 10.01) + 2 custom buffers		automatic, up to 5 points with 7 memorized values (pH 1.68, 4.01, 6.86, 7.01, 9.18, 10.01, 12.45) + 2 custom buffers	
Analog Output		—			
Temperature Compensation		automatic (with HI 7669/2W probe) or manual from -9.9 to 120°C			
pH Electrode		HI 1131B, glass-body, double junction, refillable, BNC connector, 1 m cable (included)			
Temperature Probe		HI 7669/2W with 1 m (3.3') cable (included)			
Input Impedance		10 ¹² Ohm			
PC Connection		—	RS232 opto-isolated serial port		
Power Supply		12 Vdc adapter (included)			
Environment		0 to 50°C (32 to 122°F); RH max 95%			
Dimensions / Weight		240 x 182 x 74 mm (9.4 x 7.2 x 2.9") / 1.1 kg (2.4 lbs.)			

ORDERING INFORMATION

HI 110*, HI 111*, HI 112* and HI 113* are supplied with HI 1131B pH electrode, HI 7669/2W temperature probe, pH 4 and pH 7 buffer sachets (20 mL ea.), electrode refilling solution, electrode holder, 12 Vdc power adapter and instructions.

ELECTRODES

HI 1131B Refillable pH electrode with BNC connector with 1m (3.3') cable

HI 7669/2W Temperature probe

SOLUTIONS

HI 5004 pH 4.01 buffer solution, 500 mL

HI 5007 pH 7.01 buffer solution, 500 mL

HI 5010 pH 10.01 buffer solution, 500 mL

HI 54710 pH 4.01, pH 7.01 and pH 10.01 buffer solution, 500 mL ea.

HI 70300L Electrode storage solution, 500 mL

HI 7061L Electrode cleaning solution, 500 mL

ACCESSORIES

HI 76404 Electrode holder

HI 92000 Windows® compatible software

HI 920010 Serial cable for PC connection

HI 710005 115 Vac/12 Vdc pwr adapter (US)

HI 710006 230 Vac/12 Vdc pwr adapter (EU)

HI 8427 pH/mV electrode simulator

HI 931001 pH/mV electrode simulator with display

* Supplied with 115V (add -1)
or (add -2) 230V power supply



HI 207 • HI 208

All in One pH Meters

for Education

ISE/pH
Portable Meters

All in One.

Built-in magnetic stirrer*, built-in beaker holder and beaker-top electrode holder in one compact, lightweight unit.

Optimize Space in Busy Classrooms

HI 207 and HI 208 are All-in-One pH meters designed to meet classroom environments with features such as a built-in beaker holder, beaker-top electrode holder and 2-in-1 pH and temperature sensor. These instruments also feature an extended pH range, dual-level LCD with icons for stability and buffer recognition, automatic pH calibration with 2 sets of memorized buffers, Celsius or Fahrenheit temperature range and automatic temperature compensation. In the classroom, these compact units reduce clutter and utilize a minimal amount of space on the desktop. Switch to battery power and the instrument can be taken outside the classroom for field studies. The units' small footprint enables them to be used in places usually not suitable for large, multi-unit set-ups. When lab time is over, the instruments are easily cleaned and can be placed out of the way—right away. HI 207 and HI 208 operate with the supplied 12 Vdc adapter or batteries.

- Built-in Magnetic Stirrer*
- Built-in Beaker holder and beaker-top electrode holder
- Dual-level LCD
- Automatic calibration
- °C and °F temperature scales
- Battery operated for portability, 12 Vdc power supply for stability
- Easy set-up and storage
- Compact and lightweight

* Built-in magnetic stirrer for HI 208 only



HI 207 • HI 208

All in One pH Meters

for Education

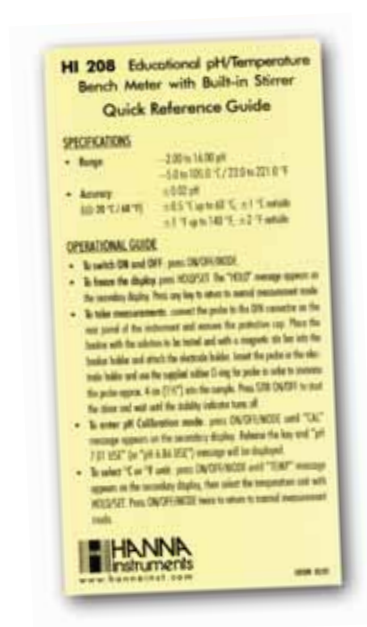

Double-sided quick reference guide included

When lab time is over, the instruments are easily cleaned and can be placed out of the way—right away.



HI 207 without stirrer

HI 208 with stirrer



HI 740038 — Electrode Holder and Plastic 50 mL beaker

Specifications		HI 207	HI 208
Range	pH	-2.00 to 16.00 pH	
	Temperature	-5.0 to 105.0°C / 23.0 to 221.0°F (Limited to 80°C/176°F using HI 1291D probe)	
Resolution	pH	0.01 pH	
	Temperature	0.1°C / 0.1°F	
Accuracy (@20°C)	pH	±0.02 pH	
	Temperature	±0.5 (up to 60°C); ±1°C (up to 105°C) ±1°F (up to 140°F); ±2°F (up to 221°F) (excluding probe error)	
pH Calibration		automatic, 1 or 2 point with 2 sets of standardized buffer values (pH 4.01/7.01/10.01 or 4.01/6.86/9.18)	
Temperature Compensation		automatic, -5 to 105°C (23 to 221°F), for pH readings	
Electrode		HI 1291D pH electrode with built-in temperature sensor (included)	
Built-in Magnetic Stirrer		No	Yes
Battery Type / Life		9V AA / approx. 200 hours of continuous use (without stirrer)	
Power supply		12 Vdc power supply	
Environment		0 to 50°C (32 to 122°F); RH max 95%	
Dimensions / Weight		192 L x 104 W x 134 H mm (7.5 L x 4.1 W x 5.2 H") / 420 g (14.8 oz.)	

ORDERING INFORMATION

HI 207-01(115V), HI 207-02 (230V), HI 208-01 (115V) and HI 208-02 (230V) All in One are supplied with HI 1291D pH electrode with built-in temperature sensor, plastic beaker, pH electrode holder, calibration solutions, magnetic stir bar (HI 208), 12 Vdc power supply, quick reference guide and instructions.

ELECTRODES

HI 1291D Plastic body pH electrode with built-in temperature sensor and 1 m (3.3") cable

SOLUTIONS

HI 5004 pH 4.01 buffer solution, 500 mL
 HI 5007 pH 7.01 buffer solution, 500 mL
 HI 5010 pH 10.01 buffer solution, 500 mL

HI 54710 pH 4.01, pH 7.01 and pH 10.01 buffer solution, 500 mL ea.
 HI 70300L Electrode storage solution, 500 mL
 HI 7061L Electrode cleaning solution, 500 mL

ACCESSORIES

HI 740036 Plastic beakers, 50 mL (6)
 HI 740038 Electrode holder for HI 207 and HI 208 and 50 mL plastic beaker



HI 98180-HI 98185

Graphic Display pH Meters

with USB and Rechargeable Batteries

ISE/pH
Portable Meters

Rugged Portables with Backlit LCD

Ease of use and high-end features come together in our new family of pH, ISE, ORP, Conductivity and Dissolved Oxygen field instruments.

A backlit 128 x 64 pixel graphic LCD provides a clear display of measured parameters and set-up screens. Dedicated soft-keys allow fast and intuitive operation in a choice of languages with content sensitive on-screen help always available.

These instruments can be easily operated with one hand for field use and high-end models are housed in rugged waterproof casings (see charts for models). The function key operation allows users to navigate from screen to screen with immediate access to important information such as calibration status, methods set up, units and logged data.

All instruments feature log-on-demand and a USB port to transfer stored data to a computer. Other common features include a CALIBRATION DUE warning (to prevent errors due to old calibration), auto endpoint of measurement (the instrument freezes the LCD when the reading is stable), comprehensive GLP functions and °C or °F temperature display.



Feature Highlights

- Exclusive Calibration Check™
- Rechargeable batteries with inductive recharger
- Backlit, graphic LCD and battery life on display
- Menu driven
- Rugged, durable casing
- Soft-key extended functionality
- Multiple language selection
- Comprehensive GLP functions

ISE

- Direct measurement in multiple units (ppm, ppt, g/L, mg/L, ppb, µg/L, mg/mL, M, mol/L, mmol/L, %w/v, user)
- Electrode type selection
- Up to 5 calibration points

pH

- Calibration Check™
- 0.001 pH resolution
- pH electrode with a built-in temperature sensor (select models)
- Up to 5 calibration points with standard or custom buffers (select models)
- Relative mV scale



Measurement

Large backlit graphic display shows multiple messages along with the current measurement readings.



Help

Users can consult the on-screen help from any mode simply by pressing the HELP key. The instrument will then explain the function and options currently available.



pH Measurement Screen

Electrode condition and calibration points shown.



pH Calibration

Detailed Calibration Check™ messages.



ISE Calibration

Up to 5 point calibration with 6 standard solutions. Users are guided through the calibration procedure with step-by-step on-screen instructions.

HI 98180-HI 98185

Graphic Display pH Meters

with USB and Rechargeable Batteries

Meters with pH and ORP ...

All meters feature HANNA's exclusive Calibration Check™: during calibration the pH electrode state is compared to the previous calibration and the user is warned in the event of significant changes to avoid erroneous calibration due to a bad/dirty electrode or a contaminated buffer. The electrode condition is always displayed on the LCD and the OUT OF CALIBRATION RANGE warning alerts the user if the measurement is taken too far from the calibration points.

For added versatility, these meters offer up to 5 calibration points using either HANNA's standard or user defined buffer values. An mV scale is also available for ORP measurements.



Specifications		HI 98180	HI 98181	HI 98182	HI 98183
Range	pH	-2.0 to 16.0; -2.00 to 16.00 pH		-2.0 to 20.0; -2.00 to 20.00; -2.000 to 20.000 pH	
	mV	—	±2000 mV	±2000 mV	
	Temperature	-20.0 to 120.0 °C (-4.0 to 248.0°F)		-20.0 to 120.0 °C (-4.0 to 248.0°F)	
Resolution	pH	0.1; 0.01 pH		0.1; 0.01; 0.001 pH	
	mV	—	0.1 mV	0.1 mV	
	Temperature	0.1°C (0.1°F)		0.1°C (0.1°F)	
Accuracy (@20°C)	pH	±0.01 pH		±0.01; ±0.002 pH	
	mV	—	±0.2mV	±0.2mV	
	Temperature	±0.4°C (±0.8°F) (excluding probe error)		±0.4°C (±0.8°F) (excluding probe error)	
Calibration	pH	Up to 2 point calibration, 7 standard buffers available (1.68, 4.01, 6.86, 7.01, 9.18, 10.01, 12.45)	Up to 3 point calibration, 7 standard buffers available (1.68, 4.01, 6.86, 7.01, 9.18, 10.01, 12.45)	Up to 5 point calibration, 7 standard buffers available (1.68, 4.01, 6.86, 7.01, 9.18, 10.01, 12.45) + 5 custom buffers	
	Slope	From 80 to 110%		From 80 to 110%	
Temperature Compensation	Manual or automatic from -20.0 to 120.0°C (-4.0 to 248.0°F)			Manual or automatic from -20.0 to 120.0°C (-4.0 to 248.0°F)	
Probes	HI 1230B pH electrode w/BNC and HI 7662 temperature probe		HI 1230B pH w/BNC and HI 7662 temperature probe		HI 72911B pH w/BNC and built-in temperature sensor
Logging	Single reading			Log-on-demand 200 samples	
PC Connectivity	—			Opto-isolated USB (with HI 92000 software)	
Input Impedance	10 ¹² Ohms				
Battery Type/Life	(4) 1.2V AA rechargeable batteries/approx. 200 hrs continuous use (without backlight)				
Recharger	HI 710042 inductive recharger (included)				
Auto-off	User Selectable: 5, 10, 30, 60 min or can be disabled				
Environment	0 to 50°C (32 to 122°F); RH 95%		0 to 50°C (32 to 122°F); RH 95%		IP67
Dimensions/Weight	226.5 x 95 x 52 mm (8.9 x 3.75 x 2")/525 g (18.5 oz.)				

ORDERING INFORMATION

HI 98180*, HI 98181* and HI 98182* are supplied with HI 1230B pH electrode and HI 7662 temperature probe, pH 4.01 and pH 7.01 buffer solutions, rechargeable batteries (4), HI 710042 inductive battery charger with power adapter, rugged carrying case and instructions.

HI 98183* is supplied with HI 72911B pH electrode with built-in temperature sensor, pH 4.01 and pH 7.01 buffer solutions, rechargeable batteries (4), HI 710042 inductive battery charger with power adapter, rugged carrying case and instructions.

* Supplied with 115V (add -1) or (add -2) 230V power supply

Graphic Display pH Meters

with USB and Rechargeable Batteries

... and pH, ORP with ISE

In addition to all the features of the pH models, these meters also include direct ion concentration determination with ion selective electrodes.

HI 98185 allows a choice of measurement units (*ppm, ppt, g/L, mg/L, ppb, µg/L, mg/mL, M, mol/L, mmol/L, % w/v, user*) and ISE type selection (*ammonia, bromide, cadmium, calcium, carbon dioxide, chloride, cupric, fluoride, iodide, lead, nitrate, potassium, silver, sulfate and sulfide*).

HI 98184 measures in ppm and the ion charge or nominal electrode slope can be entered manually.

Up to 5 calibration points with six standard values are available.



Rechargeable batteries with inductive recharger

These models have up to 200 hour extended battery life to guarantee long operation in the field. When the batteries are low, you don't have to worry about carrying a spare set with you—the batteries can be recharged with HANNA's inductive recharger. Simply leave the meter on the recharger for a few hours and you're ready to go. The recharger can either be plugged to a standard 115V or 230V socket using the included HANNA adapter or into a 12 Vdc source such as a car's 12 Volt accessory outlet.



Specifications		HI 98184	HI 98185
Range	pH	-2.0 to 20.0; -2.00 to 20.00; -2.000 to 20.000 pH	
	mV	±2000 mV	
	ISE	From 1.00 x 10 ⁻³ to 1.00 x 10 ³ ppm	From 1.00 x 10 ⁻⁷ to 9.99 x 10 ¹⁰ concentration (choice of units)
	Temperature	-20.0 to 120.0 °C (-4.0 to 248.0 °F)	
Resolution	pH	0.1; 0.01; 0.001 pH	
	mV	0.1 mV	
	ISE	3 digits 0.01; 0.1; 1; 10 concentration	
	Temperature	0.1 °C (0.1 °F)	
Accuracy	pH	±0.01; ±0.002 pH	
	mV	±0.2 mV	
	ISE	±0.5% of reading (monovalent ions), ±1% of reading (divalent ions)	
	Temperature	±0.4 °C (±0.8 °F) (excluding probe error)	
Calibration	pH	Up to 5 point calibration, 7 standard buffers available (1.68, 4.01, 6.86, 7.01, 9.18, 10.01, 12.45) + 5 custom buffers	
	ISE	Up to 2 point calibration, 6 standard solutions (0.1, 1, 10, 100, 1000, 10000 ppm)	Up to 5 point calibration, 6 standard solutions (choice of units)
	Slope	From 80 to 110%	
Temperature Compensation (pH)	Manual or automatic from -20.0 to 120.0 °C (-4.0 to 248.0 °F)		
Probes	HI 72911B pH w/BNC and built-in temperature sensor		
Logging	Log-on-demand 300 samples (100 each range)		
PC Connectivity	Opto-isolated USB (with HI 92000 software)		
Input Impedance	10 ¹² Ohms		
Battery Type/Life	(4) 1.2V AA rechargeable batteries/ approx. 200 hrs continuous use (with backlight off)		
Recharger	HI 710042 inductive recharger (included)		
Auto-off	User Selectable: 5, 10, 30, 60 min or can be disabled		
Environment	IP67		
Dimensions/Weight	226.5 x 95 x 52 mm (8.9 x 3.75 x 2")/525 g (18.5 oz.)		

ORDERING INFORMATION cont.

HI 98184-01 (115V), HI 98184-02 (230V), HI 98185-01 (115V) and HI 98185-02 (230V) are supplied with HI 72911B pH electrode with built-in temperature sensor, pH 4.01 and pH 7.01 buffer solutions, rechargeable batteries (4), HI 710042 inductive battery charger with power adapter, rugged carrying case and instructions.

ORDERING INFORMATION cont.

ELECTRODES

Combination pH electrodes. All part codes ending with P are provided with BNC & Pin connectors, and 1 m (3.3') cable.

- HI 1043P** Use: *strong acids and bases*. Glass-body, double junction, refillable
- HI 1053P** Use: *emulsions*. Glass-body, triple ceramic junction, refillable
- HI 1083P** Use: *biotechnology*. Glass-body, open junction, refillable
- HI 1131P** Use: *general purpose*. Glass-body, ceramic junction, refillable
- HI 1332P** Use: *general purpose*. PEI body, double junction, refillable

SOLUTIONS

- HI 5004** pH 4.01 buffer solution, 500 mL
- HI 5007** pH 7.01 buffer solution, 500 mL
- HI 5010** pH 10.01 buffer solution, 500 mL
- HI 54710** pH 4.01, pH 7.01 and pH 10.01 buffer solution, 500 mL ea.
- HI 70300L** Electrode storage solution, 500 mL
- HI 7061L** Electrode cleaning solution, 500 mL

ACCESSORIES

- HI 7855/1** 1 m (3.3') Extension cable for electrodes (screw-type to BNC)
- HI 7855/3** 3 m (9.9') Extension cable for electrodes (screw-type to BNC)
- HI 710042** Inductive battery recharger
- HI 7662** Temperature probe with 1 m (3.3') screened cable
- HI 740157** Plastic electrode refilling pipettes (20)
- HI 76405** Electrode holder
- HI 920013** USB cable for PC connection
- HI 92000** Windows® compatible software

HI 98170 • HI 98171 • HI 98172

pH/ORP/ISE Meters

with HANNA's Exclusive Calibration Check™



Splashproof Keypad

3 Models to Meet Your Application Requirements

HI 9817x series are state-of-the-art, heavy-duty portable pH meters with temperature probe input—this means changing one probe with another is easy (e.g., pH for ORP). Housed in a waterproof casing, these units are specifically designed to provide laboratory results and accuracy under demanding industrial and field conditions. They come equipped with a series of new diagnostic features to dramatically improve a measurement's reliability. Up to 5 calibration points—choose from 7 memorized buffers and 5 custom buffers. This provides the user with the flexibility necessary to adjust the calibration range and obtain the most accurate and precise readings possible.

For HI 98171 and HI 98172, change the pH sensor for an ORP sensor to obtain mV readings; adjustable between two ranges and accurate to ± 0.2 mV.

For HI 98172, ISE sensors are calibrated up to 5 points and measurements are obtained in ppm concentrations.

All meters support HANNA's signature Calibration Check™. Calibration Check™ displays an electrode condition graph which informs the user of electrode status during calibration. If readings are taken too far outside the calibration range, the unit will warn the user with a graphic signal. Users may set a reminder to notify when calibration is due.

The HI 9817x Series is equipped with auto-end measuring mode that ensures readings are taken only when they are stable. GLP data is instantly accessible via a dedicated GLP key and Log-on-demand holds up to 150 records. All data can be downloaded to a PC via the RS232 connection. With up to 200 hours of extended battery life, these units will guarantee long operation in the field.

Key Features

- Measure pH, mV or ISE with temperature
- Electrode diagnostics
- Backlit LCD with battery life on the display
- Docking station for battery recharge
- Waterproof protection
- "Outside Calibration Range" warning
- Settable "Cal Due" warning on display
- Up to 5 calibration points in 7 standard buffers
- Up to 5 custom buffers
- °C or °F unit selection
- Log On Demand up to 150 records (50 each range)
- Auto-end feature
- GLP feature
- RS232 PC connectivity (with HI 92000 software)

Screen Highlights



Backlit Display

Large backlit display shows current measurement readings along with the electrode condition and battery life.



GLP

Comprehensive GLP functions are directly accessible by pressing the GLP key.



Calibration Messages

Messages on the LCD make calibration easy and accurate.

HI 98170 • HI 98171 • HI 98172 pH/ORP/ISE Meters

with HANNA's Exclusive Calibration Check™

Electrode Condition Graph

Provides a quick and clear indication of electrode status after calibration.



Bargraph Indication	Condition value
All 5 bars	 81 - 100%
4 bars	 61 - 80%
3 bars	 41 - 60%
2 bars	 21 - 40%
1 bar	 1 - 20%
1 bar blinking	 0%
Frame only	 Info not available

HI 710041 Inductive Battery Recharger

When the batteries are low, you don't have to worry about carrying a spare set with you—the batteries can be recharged with HANNA's inductive recharger. Simply leave the meter on the recharger for a few hours and you're ready to go!



Plug the recharger into a standard 115V or 230V socket or a 12 Vdc source such as a car's 12V accessory outlet.

ORDERING INFORMATION

HI 98170*, HI 98171* and HI 98172* are supplied with HI 1230B double-junction, pH electrode, HI 7662 stainless steel temperature probe, pH 4.01 and pH 7.01 buffer solutions (20 mL ea.), 100 mL plastic beaker, rechargeable batteries (4), HI 710041 inductive recharger with power adapter, rugged carrying case and instructions.

SOLUTIONS

- HI 5004** pH 4.01 buffer solution, 500 mL
- HI 5007** pH 7.01 buffer solution, 500 mL
- HI 5010** pH 10.01 buffer solution, 500 mL
- HI 54710** pH 4.01, pH 7.01 and pH 10.01 buffer solution, 500 mL ea.
- HI 7091L** ORP reducing pretreatment solution, 500 mL
- HI 7092L** ORP oxidizing pretreatment solution, 500 mL
- HI 7021L** ORP test solution @240 mV, 500 mL
- HI 7022L** ORP test solution @470 mV, 500 mL
- HI 70300L** Electrode storage solution, 500 mL
- HI 7061L** Electrode cleaning solution, 500 mL

ACCESSORIES

- HI 710041** Inductive battery recharger
- HI 920010** RS232 cable for PC connection
- HI 92000** Windows® compatible software

SPECIFICATIONS		HI 98170	HI 98171	HI 98172
Range	pH	-2.0 to 16.0; -2.00 to 16.00 pH		-2.00 to 16.00 pH
	mV	—	±699.9 mV; ±2000 mV	
	ISE	—		0.001 to 19990 ppm
	Temperature	-20.0 to 120.0 °C (-4.0 to 248.0°F)		
Resolution	pH	0.1; 0.01 pH		0.01 pH
	mV	—	0.1; 1 mV	
	ISE	—		0.001 ppm (from 0.001 to 1.999) 0.01 ppm (from 2.00 to 19.99) 0.1 ppm (from 20.0 to 199.9) 1 ppm (from 200 to 1999) 10 ppm (from 2000 to 19990)
	Temperature	0.1° (0.1°F)		
Accuracy	pH	±0.1; ±0.01 pH		±0.01 pH
	mV	—	±0.2 mV (±699.9 mV); ±1 mV (±2000 mV)	
	ISE	—		±0.5% f.s.
	Temperature	±0.4°C (±0.8°F) excluding probe error		
Temperature	Range	-20.0 to 120.0 °C (-4.0 to 248.0°F)		
	Resolution	0.1° (0.1°F)		
	Accuracy	±0.4°C (±0.8°F) excluding probe error		
pH Calibration	Up to 5 calibration points; 7 standard buffers available (pH buffers 1.68, 4.01, 6.86, 7.01, 9.18, 10.01, 12.45) and 5 custom buffers			
ISE Calibration	—		Up to 5 point calibration, 6 standards available (0.1, 1, 10, 100, 1000, 10000 ppm)	
Slope/Offset Calibration	±1 pH/From 80 to 110%			
Relative mV Offset Range	—		±2000 mV	
Temperature Compensation	Automatic or manual from -20.0 to 120.0°C (-4.0 to 248.0°F)			
Electrodes	HI 1230B pH electrode; HI 7662 temperature probe (included)			
Logging	On demand, 50 samples on each range			
Computer Interface	RS232 (HI 92000 software required)			
Input Impedance	10 ¹² Ohm			
Battery Type/Life	(4) 1.2V AA rechargeable batteries, approx. 200 hrs continuous use without backlight. Battery charger included. User-selectable auto off: 1-30 min. or disabled.			
Environment	0 to 50°C (32 to 122°F); RH 100%			
Dimensions/Weight	196 x 80 x 60 mm (7.7 x 3.1 x 2.4")/ 425 g (15 oz.)			

* Supplied with 115V (add -1)
or (add -2) 230V power supply

HI 98160

Auto-Endpoint pH Meter

Store and Recall up to 500 Measurements



- Backlit, dual-level LCD
- 8 standard buffers for calibration
- Store and recall up to 500 measurements
- HOLD button to freeze display
- Extended pH and temperature ranges
- PC compatible through RS232 serial port
- Battery Error Prevention System
- Supplied ready to use in a hard carrying case



HI 70300L — Electrode Storage Solution

Auto-Endpoint for Accurate Recording

The portable HI 98160 pH meter greatly simplifies the process of recording measurements with our new Auto-Endpoint feature. This feature automatically enters the HOLD mode when the reading is stable for easy recording of on-screen measurements.

HI 98160 is equipped with automatic calibration at 1 or 2 points (choose from 8 standard buffers) and assures reliable readings over the entire measurement range.

HI 98160 has a backlit display making readings clear even in dark environments.

Users can store information pertaining to each reading at the touch of a button. More than 500 measurements, complete with date and time, can be stored and recalled. Measurements can also be transferred to the computer via the RS232 serial port, using the optional HI 92000 Windows® compatible software and HI 920011 connection cable.

Specifications		HI 98160
Range	pH	-4.00 to 19.99 pH
	mV	±600.0 mV; ±2000 mV
	Temperature	-20.0 to 120.0°C
Resolution	pH	0.01 pH
	mV	0.1 mV (±400 mV); 0.2 mV (±400 to ±600 mV); 1 mV (outside)
	Temperature	0.1°C (-10 to 120°C); 1°C (below -10°C)
Accuracy (@20°C)	pH	±0.01 pH
	mV	±0.2 mV (±400 mV); ±0.4 mV (±400 to ±600); ±2 mV (outside)
	Temperature	±0.2°C (0 to 70°C); ±1°C (outside) (excluding probe error)
pH Calibration		automatic, 1 or 2 point with 8 standard buffer values (pH 1.68, 3.00, 4.01, 6.86, 7.01, 9.18, 10.01, 12.45)
mV Calibration		automatic, 2 point at 0, 350 mV or 3 point at 0, 350, 1900 mV
Temperature Compensation		automatic or manual, -20 to 120°C (-4 to 248°F)
pH Electrode		HI 1230B/C double junction, gel filled, BNC connector with protective sleeve (included)
Temperature Probe		HI 7662 (included)
PC Connection		through RS232 serial port, using HI 920011 connection cable (optional) and HI 92000 software (optional)
Input Impedance		10 ¹² Ohm
Battery Type / Life		(4) 1.5V AA / approx. 300 hours of continuous use (with backlight off)
Environment		0 to 50°C (32 to 122°F); RH max 100%
Dimensions / Weight		196 x 80 x 60 mm (7.7 x 3.1 x 2.4") / 500 g (1.1 lbs.)

ORDERING INFORMATION

HI 98160 is supplied with HI 1230B/C pH electrode, HI 7662 temperature probe, pH 4 and pH 7 buffer sachets, electrode cleaning solution, batteries, rugged carrying case and instructions

ELECTRODES

- HI 1230B/C** pH electrode, double junction, PEI body, BNC connector with protective sleeve, 1 m (3.3') cable
- HI 3131B** ORP electrode, glass body, refillable with platinum sensor and BNC connector, 1 m (3.3') cable
- HI 7662** Temperature probe

SOLUTIONS

- HI 5004** pH 4.01 buffer solution, 500 mL
- HI 5007** pH 7.01 buffer solution, 500 mL
- HI 5010** pH 10.01 buffer solution, 500 mL
- HI 54710** pH 4.01, pH 7.01 and pH 10.01 buffer solution, 500 mL ea.
- HI 70300L** Electrode storage solution, 500 mL
- HI 7061L** Electrode cleaning solution, 500 mL

ACCESSORIES

- HI 92000** Windows® compatible software
- HI 920011** RS232 cable for PC connection



HI 9026

Calibration Check™ pH Meter

Capable of Withstanding Harsh Industrial Conditions

ISE/pH
Portable Meters

Withstands the Punishment of Heavy Use

HI 9026 is an advanced pH/ORP meter specifically designed to provide affordable and precise results under harsh industrial conditions.

Choose from 7 standard buffer values for pH calibration or program up to 2 custom buffer values to best fit to your application. Utilizing HANNA's advanced Calibration Check™, when calibration is complete, the electrode condition is displayed indicating that either the electrode is working properly or it needs to be cleaned or replaced. Users can also set up a calibration reminder from 1 to 14 days and be alerted when it is time to recalibrate the meter.

HI 9026 is housed in a waterproof casing and can be used with ORP electrodes.



Easy On-screen Guide

Users can select parameters such as sound, auto-off timer, temperature scale, special calibration segments and "Expired Calibration Timer".



Message Alerts

During calibration the HI 9026 continuously checks calibration parameters. This feature alerts the user when the electrode is dirty and could cause erroneous measurements.

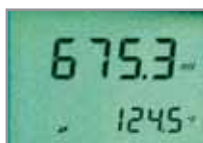

Backlit LCD

The backlit LCD allows users to perform measurements in poorly lit locations.



4 7

Tags indicating the pH buffers used for last calibration

Specifications		HI 9026
Range	pH	-2.00 to 16.00 pH
	mV	±699.9 mV; ±1999 mV
	Temperature	-20.0 to 120.0°C / -4.0°F to 248.0°F
Resolution	pH	0.01 pH
	mV	0.1 mV; 1 mV
	Temperature	0.1°C / 0.1 °F
Accuracy (@20°C)	pH	±0.01 pH
	mV	±0.2 mV; ±1 mV
	Temperature	±0.4°C / ±0.8°F
Calibration Check	check of the electrode status during calibration	
pH Calibration	automatic, 1 or 2 point with 7 memorized buffer values (pH 1.68, 4.01, 6.86, 7.01, 9.18, 10.01, 12.45) + 2 custom buffers	
Temperature Compensation	automatic or manual, -20 to 120°C (-4 to 248°F)	
pH Electrode	HI 1230B, double junction, PEI body, gel filled, BNC connector and 1 m (3.3') cable (included)	
Temperature Probe	HI 7662 with 1 m (3.3') cable (included)	
Input Impedance	10 ¹² Ohm	
Battery Type / Life	(4) 1.5V AA / approx. 500 hours of continuous use (with backlight off); auto-off after 20 minutes of non-use (can be disabled)	
Environment	0 to 50°C (32 to 122°F); RH max 100%	
Dimensions / Weight	196 x 80 x 60 mm (7.7 x 3.1 x 2.4") / 500 g (1.1 lbs.)	

ORDERING INFORMATION

HI 9026 is supplied with HI 1230B pH electrode, HI 7662 temperature probe, pH 4 and pH 7 buffer sachets, 100 mL plastic beaker, batteries, rugged carrying case and instructions.

ELECTRODES

- HI 1230B** pH electrode, double junction, PEI body, BNC connector, 1 m (3.3') cable
- HI 3230B** ORP electrode, gel filled, PEI body, with platinum sensor, BNC connector, 1 m (3.3') cable
- HI 7662** Temperature probe

SOLUTIONS

- HI 5004** pH 4.01 buffer solution, 500 mL
- HI 5007** pH 7.01 buffer solution, 500 mL
- HI 5010** pH 10.01 buffer solution, 500 mL
- HI 54710** pH 4.01, pH 7.01 and pH 10.01 buffer solution, 500 mL ea.
- HI 70300L** Electrode storage solution, 500 mL
- HI 7061L** Electrode cleaning solution, 500 mL

ACCESSORIES

- HI 76405** Electrode holder
- HI 721317** Rugged carrying case

- Exclusive Calibration Check™
- Backlit, dual-level LCD
- pH electrode, temperature probe and hard carrying case included!
- Electrode monitoring
- 7 standard buffers for calibration and 2 custom buffers
- Display hold and memory storage
- Real time clock for accurate calibration monitoring
- User-selectable calibration reminder
- Extended pH and temperature ranges
- Measures in °C or °F
- Stability indicator
- Waterproof



HI 721317 — Carrying Case

HI 9024 • HI 9025

Auto-Instruction pH Meters

Ideal for Lab or Field Use



Two of our Most Popular Meters!

HI 9024 and HI 9025 are microprocessor-based pH meters in waterproof casings. Both meters measure pH and temperature while HI 9025 adds ORP measurement in the mV range.

HI 9024 and HI 9025 are housed in rugged and waterproof ABS casings that can withstand harsh environments.

The Auto-Instruction feature guides the user step-by-step through the calibration process with graphic symbols.

The automatic calibration procedure is simple and quick and can be performed at 1 or 2 points selected from 5 memorized buffers. A stability indicator assures a correct calibration, and to preserve battery life, both meters feature automatic shut-off.

- 5 memorized buffers for calibration
- Measures temperature in °C or °F
- Automatic pH calibration
- Battery Error Prevention System
- Supplied ready to use in a hard carrying case

Specifications		HI 9024	HI 9025
Range	pH	0.00 to 14.00 pH	
	mV	—	±399.9 mV; ±1999 mV
	Temperature	0.0 to 100.0°C / 32.0°F to 212.0°F	
Resolution	pH	0.01 pH	
	mV	—	0.1 mV; 1 mV
	Temperature	0.1°C / 0.1°F	
Accuracy (@20°C)	pH	±0.01 pH	
	mV	—	±0.2 mV; ±1 mV
	Temperature	±0.4°C / ±0.8°F	
pH Calibration		automatic, 1 or 2 point with 5 standard buffer values (pH 4.01, 6.86, 7.01, 9.18, 10.01); offset calibration: ±1 pH; slope calibration: 70 to 108%	
Temperature Compensation		automatic or manual, -5 to 105°C (23°F to 221°F)	
pH Electrode		HI 1230B, double junction, gel filled, BNC connector and 1 m cable (included)	
Temperature Probe		HI 7669/2W with 1 m (3.3') cable (included)	
Input Impedance		10 ¹² Ohm	
Battery Type / Life		(4) 1.5V AA / approx. 500 hours of continuous use; auto-off after 20 minutes of non-use (can be disabled)	
Environment		0 to 50°C (32 to 122°F); RH max 100%	
Dimensions / Weight		196 x 80 x 60 mm (7.7 x 3.1 x 2.4") / 500 g (1.1 lbs.)	

ORDERING INFORMATION

HI 9024 and **HI 9025** are supplied with HI 1230B double-junction pH electrode, HI 7669/2W temperature probe, pH 4.01 and 7.0 buffer solutions, 20 mL, sample vessel, batteries (4), rugged carrying case and instructions.

ELECTRODES

HI 1230B pH electrode, double junction, PEI body, BNC connector with 1 m (3.3') cable

HI 3230B ORP electrode, gel filled, PEI body, BNC connector with 1 m (3.3') cable

HI 7669/2W Temperature probe

SOLUTIONS

HI 5004 pH 4.01 buffer solution, 500 mL

HI 5007 pH 7.01 buffer solution, 500 mL

HI 5010 pH 10.01 buffer solution, 500 mL

HI 54710 pH 4.01, pH 7.01 and pH 10.01 buffer solution, 500 mL ea.

HI 70300L Electrode storage solution, 500 mL

HI 7061L Electrode cleaning solution, 500 mL

ACCESSORIES

HI 76405 Electrode holder

HI 8427 pH/mV electrode simulator

HI 931001 pH/mV electrode simulator with display



HI 8427 — pH/mV Electrode Simulator



HI 76405 — Electrode Holder



pH • ORP • Conductivity • TDS
Waterproof Testers

HANNA's *World-renowned Design*

The World's Most Advanced Line Of Testers

With these powerful waterproof testers, you can easily measure pH, EC, TDS, temperature, and ORP anywhere. HANNA always pays strict attention to detail and it's evident in these advanced instruments. With features such as replaceable electrode cartridge technology, dual-level LCD's and stainless steel temperature probes, HANNA once again ensures precise and responsive measurements. In addition, EC/TDS testers utilize replaceable graphite probe cartridges for fast response and contamination resistance.

At startup, each tester performs a self check and then displays the remaining battery level assuring proper working condition. A stability indicator tells you when to take the reading and a HOLD button freezes the display for easy and accurate recording. All information is displayed on a redesigned LCD that gives you the complete picture at a glance.

- *Dual-level LCD*
- *Cloth, renewable junction*
- *Close proximity temperature probe*
- *Replaceable electrode cartridge*
- *Battery Error Prevention System (BEPS)*
- *Automatic Temperature Compensation*
- *Automatic calibration*
- *Tactile grip casings*
- *Waterproof and floating*
- *Automatic shut-off*
- *Efficient 2-button operation*
- *Temperature in °C or °F*



Replaceable Electrode

HANNA uses exclusive replaceable cartridge electrodes. The stainless steel round connector of the electrode means there are no pins to bend or break during replacement.



Contamination Resistant Conductivity Probe

HANNA's graphite conductivity probe resists contamination from salt deposits in the solution.



Rejuvenating pH Junction

The pH replaceable electrode features a pull-out cloth junction. When the cloth junction becomes dirty from routine testing, simply pull out 3 mm (1/8") to rejuvenate the electrode.



Close Proximity Temperature Probe

An exposed temperature probe provides faster response times. Its close proximity guarantees more accurate temperature compensated readings.

pH • ORP • Conductivity • TDS
Waterproof Testers

HANNA's World-renowned Design

HANNA testers are the perfect combination of function and form.



SPECIFICATIONS

		pHep ^{®4}	pHep ^{®5}	DiST ^{®5}	DiST ^{®6}	ORP	pH/ORP Combo	pH/EC Combo	pH/EC Combo
Model Number		HI 98127	HI 98128	HI 98311	HI 98312	HI 98120	HI 98121	HI 98129	HI 98130
Range	pH: -2.0 to 16.0 pH	•							
	pH: -2.00 to 16.00 pH		•				•		
	pH: 0.00 to 14.00 pH							•	•
	EC: 0 to 3999 µS/cm			•				•	
	EC: 0.00 to 20.00 mS/cm				•				•
	TDS: 0 to 2000 ppm			•					•
	TDS: 0.00 to 10.00 ppt				•				•
	ORP: ±1000 mV					•	•		
	Temp.: -5.0 to 60.0°C/23.0 to 140.0°F	•	•			•	•		
Temp.: 0.0 to 60.0°C/32.0 to 140.0°F			•	•				•	
Resolution	0.1 pH	•							
	0.01 pH		•				•		•
	1 µS/cm EC			•				•	
	0.01 mS/cm EC				•				•
	1 ppm TDS							•	
	0.01 ppt TDS				•				•
	1 mV ORP					•	•		
0.1°F/°C	•	•	•	•	•	•	•	•	
Accuracy (@20°C/68°F)	±0.1 pH	•							
	±0.05 pH		•				•	•	•
	±2% F.S. EC/TDS			•	•			•	•
	±2 mV ORP					•	•		
	±0.5 °C	•	•	•	•	•	•	•	•
±1 °F	•	•	•	•	•	•	•	•	
Calibration	pH Automatic*	•	•				•	•	•
	EC/TDS Automatic**			•	•			•	•
Automatic Temperature Compensation		•	•	•	•	•	•	•	•
Battery Type		(4) 1.5V	(4) 1.5V	(4) 1.5V	(4) 1.5V	(4) 1.5V	(4) 1.5V	(4) 1.5V	(4) 1.5V
Battery Life (hours)		300	300	100	100	300	250	100	100
Battery Error Prevention System (BEPS)		•	•	•	•	•	•	•	•
Auto-off after 8 minutes		•	•	•	•	•	•	•	•
Dimensions/Weight		163 x 40 x 26 mm(6.4 x 1.6 x 1")/85 g (3.0 oz)							

*1 or 2 points with 2 sets of memorized buffers, (pH 4.01/7.01/10.01 or pH 4.01/6.86/9.18) **1 point at 1413 µS/cm or 12.88 mS/cm

ORDERING INFORMATION

All testers are supplied with cap, electrode removal tool, batteries and instruction manual.

SOLUTIONS

- HI 50004-02** pH 4.01 buffer solution, (25) 20 mL sachets
- HI 50007-02** pH 7.01 buffer solution, (25) 20 mL sachets
- HI 50010-02** pH 10.01 buffer solution, (25) 20 mL sachets
- HI 7021L** ORP test solution @240 mV, 500 mL
- HI 7022L** ORP test solution @470 mV, 500 mL
- HI 70030P** 12.88 mS/cm @ 25°C calibration solution, (25) 20 mL sachets

- HI 70031P** 1413 µS/cm @ 25°C calibration solution, (25) 20 mL sachets
- HI 70032P** 1382 ppm @ 25°C calibration solution, (25) 20 mL sachets
- HI 70038P** 6.44 ppt @ 25°C calibration solution, (25) 20 mL sachets
- HI 70442P** 1500 ppm @ 25°C calibration solution, (25) 20 mL sachets
- HI 70300M** Electrode storage solution, 250 mL
- HI 7061L** Electrode cleaning solution, 500 mL

ACCESSORIES

- HI 73128** Electrode removal tool



HI 98103 Checker® pH Tester

with Replaceable Electrode



The industry's best pocket-sized pH tester at the cost of a few rolls of litmus paper

The Checker® supplies users with fast and accurate readings from 0 to 14 pH with a resolution of 0.01 pH. This compact tester features a large easy-to-read LCD and simple to perform 2-point calibration.

The pH electrode of the Checker® can be easily replaced. You only need to unscrew the electrode from the meter body and screw on a new one.

The Checker® is fast, accurate, lightweight and with 3000 hours of battery life, you don't have to worry about frequent battery replacement.

Testing pH has never been easier!

- High accuracy with 0.01 pH resolution
- 2-point fast and accurate calibration
- Usable with virtually any electrode that shares the same connector
- 3000 hours of battery life



Specifications	HI 98103 Checker®
Range	0.00 to 14.00 pH
Resolution	0.01 pH
Accuracy (@20°C/68°F)	±0.2 pH
Calibration	manual, 2 points
Electrode	HI 1270 (included)
Battery Type / Life	(2) 1.5V / approx. 3000 hours of continuous use
Environment	0 to 50°C (32 to 122°F); RH max 95%
Dimensions	66 x 50 x 25 mm (2.6 x 2.0 x 1.0") - without probe
Weight	50 g (1.8 oz.)

ORDERING INFORMATION

HI 98103 (Checker®) is supplied with HI 1270 screw-type pH electrode.

ELECTRODES

HI 1270 pH electrode with screw-type connector

SOLUTIONS

HI 50004-02 pH 4.01 buffer solution, (25) 20 mL sachets

HI 50007-02 pH 7.01 buffer solution, (25) 20 mL sachets

HI 50010-02 pH 10.01 buffer solution, (25) 20 mL sachets

HI 77400P pH 4 and pH 7 buffer solution, 20 mL sachets, (5 ea.)

HI 70300M Electrode storage solution, 250 mL

HI 7061L Electrode cleaning solution, 500 mL

HI 98107 pHep® pH Tester

with Renewable Cloth Junction

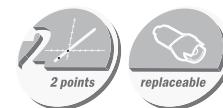

The Standard for Quick, On-The-Spot Testing

Introduced in 1986, the pHep® revolutionized pH measurement by providing everyone with a simple, inexpensive pocket pH tester.

The pHep® comes with a protective cap that doubles as a measurement vessel. With our innovative non-clogging fiber junction the pHep® lasts much longer. Simply pull out 1-2 mm (1/8") of the junction fiber to completely renew the junction.

- Easy to read LCD
- 2-point fast and accurate calibration
- 1700 hours of battery life

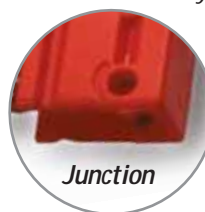

Specifications	HI 98107 (pHep®)
Range	0.0 to 14.0 pH
Resolution	0.1 pH
Accuracy (@20°C/68°F)	±0.1 pH
Calibration	manual, 2 point
Battery Type / Life	(4) 1.5V / approx. 700 hours of continuous use
Environment	0 to 50°C (32 to 122°F); RH max 95%
Dimensions	175 x 41 x 23 mm (6.9 x 1.6 x 0.9")
Weight	95 g (3.4 oz.)

ORDERING INFORMATION

HI 98107 (pHep®) is supplied with protective cap, calibration screwdriver, batteries and instructions.

ELECTRODES

HI 73106 Spare electrode for HI 98107 (replaceable by technical personnel only)

SOLUTIONS

HI 50004-02 pH 4.01 buffer solution, (25) 20 mL sachets

HI 50007-02 pH 7.01 buffer solution, (25) 20 mL sachets

HI 50010-02 pH 10.01 buffer solution, (25) 20 mL sachets

HI 77400P pH 4 and pH 7 buffer solution, 20 mL sachets, (5 ea.)

HI 70300M Electrode storage solution, 250 mL

HI 7061L Electrode cleaning solution, 500 mL

pH Electrodes

pH and ORP Electrodes Designed and Manufactured by HANNA



Combination and Special pH and ORP Electrodes

A Wide Range

In recent years technology has made considerable progress in electrode manufacturing, achieving notable high levels of accuracy. Today an electrode is an accurate, compact sensor that is easy to use. Because of its qualities and the ease with which it can be cleaned, the glass body is close to the ideal solution for measuring pH; the only problem is its fragility. This has pushed manufacturers toward the production of electrodes with a stronger protective sheathing—a plastic cylinder. This has solved the problem of fragility but at the cost of performance; plastic electrodes do not break but cannot withstand high temperatures and are more difficult to clean. Fortunately, HANNA manufactures both types of electrodes to suit a variety of applications. HANNA is the major European producer and for decades has not failed to provide technologically innovative products for its scientific clientele. We introduced the first electrode with enclosed temperature sensor in 1984 and the first pre-amplified electrode with AmpHel® connector in 1988. HANNA, backed by its many years of experience, continuously innovates in the electrode manufacturing and design field.

Water Conductivity and pH Measurement

pH measurements require some conductivity for the sample to be tested. The exact conductivity varies with electrodes, but values lower than 200 $\mu\text{S}/\text{cm}$ may be troublesome. Demineralized water does not have sufficient ionic strength for a correct pH measurement.

In the case of low conductivity values, when working below 200 $\mu\text{S}/\text{cm}$, we suggest the use of specific electrodes, such as our HI 1153B.

Tip shape

Spherical Sensor



Spherical tip is recommended for general use in aqueous or liquid solutions and provides a wide surface of contact with the sample.

Conical Tip Sensor



Conical tip is recommended for the measurement of semisolid products, emulsions, cheese, meat and food in general.

Flat Tip Sensor



Flat tip is recommended for direct surface measurement on skin, leather, paper, etc.

pH Electrodes

pH and ORP Electrodes Designed and Manufactured by HANNA

pH Measurement

pH measurements are typically performed with electrodes made with a special pH sensitive glass sensing tip. Fourteen decades of concentrations can be reliably measured using proven technology. Over the last few years, some companies have also offered ISFET technology. Fueled by the FDA's decision to avoid the use of glass in food processing, ISFETS were introduced to the marketplace but were found to suffer from drift and instability. ISFETS may have limited use, but pH glass is still the far better choice for the majority of applications.

HANNA Offers Different Shaped Membranes

Glass electrodes are available with different shaped membranes; spherical membranes, conical shaped membranes or flat tips. For analysis of small samples, micro-electrodes are also available.

HANNA Offers 4 Different pH Sensitive Glass Formulations

HANNA utilizes 4 different types of pH sensitive glass in the production of our vast offering of pH electrodes. To optimize a pH measurement for a particular application, the pH glass characteristics is considered as well as exterior materials, reference junctions and ease of use. HANNA wants to provide the best material and performance for a particular application to ensure reliability of measurement. For example, when measuring at temperature extremes, glass impedance is an important factor to consider. As a general rule, the pH glass impedance doubles for every 10°C drop in temperature. Very high impedance results in a very noisy, erratic signal that is prone to errors in measurement. HANNA offers LT a low impedance glass for these applications. At elevated temperatures, glass can dissolve readily, shortening the life and performance of the sensor. HANNA offers HT glass for these applications.

Glass Membrane	Application
GP	General Purpose
HT	High Temperature
LT	Low Temperature
HF	Samples with Fluoride

GP Glass

The GP sensitive glass represents the premium model and offers the best responses over the entire pH range and can be used for a wide range of temperature and pH. Best conditions are obtained with a sphere with a diameter of 9.5 mm (0.37") and a system with impedance of 100 MΩ, but good readings can also be obtained with spheres of smaller diameter.

As the diameter of the sphere is reduced, the system impedance increases, the response time goes from the usual 2 seconds for the 9.5 mm (0.37") sphere to about 6 seconds with a 3 mm (0.12") sphere.



HT Glass

Designed for extended use at elevated temperature and pH greater than 12. The glass impedance has a temperature coefficient of about 14.3% per degree Celsius. An electrode having an impedance of 100 MΩ at 25°C (77°F), at a temperature of 32°C (90°F) will have an impedance of about 50 MΩ and at 18°C (64°F) an impedance of about 200 MΩ. Impedances less than 1Ω are dangerous for the sensor, which will degrade in a short time.

For high temperature applications, sensitive glass with an impedance of about 400 MΩ at 25°C (77°F) has been produced. This solution makes it possible to carry out normal operations for long periods at 90°C (194°F) and for a few weeks at 100°C (212°F). It should be obvious that these electrodes are to be used with due care at room temperature where the response time rises sharply.

LT Glass

This glass should be used for low temperature work (under 60°C) and is not suited for a pH greater than 10. Temperatures below -8°C (17°F) will cause the mechanical destruction of the sensor. The system impedance should not exceed 1,000 MΩ, otherwise the reading becomes too slow, even more than 30 seconds, and this is not well suited for industrial and bench measurements. With such slow response times, process control would not be effective and for this reason a different batch of sensitive glass has been prepared with an impedance at 25°C (77°F) of 40 MΩ. At a temperature of -5°C (23°F) the impedance does not exceed 650 MΩ so that the response time is acceptable for industrial control.

HF Glass

HF sensitive glass has been produced for aggressive environments in the presence of hydrofluoric acid. With this formulation a tenfold increase has been achieved for the average life of an electrode from an average of 10 to at least 100 operating days (with pH values greater than 2 and fluorides content less than 2 g/L). The alkaline error for this type of sensitive glass is very high and is not suited for pH measurements greater than 10.00.

Combination pH and ORP Electrodes

pH and ORP Electrodes Designed and Manufactured by HANNA

HI 104XY	Connector
HI 1043B	BNC
HI 1043D	DIN
HI 1040S	Screw Cap
HI 1043P	BNC + PIN*

* For pH meters with CAL CHECK™ system

HI 105XY	Connector
HI 1053B	BNC
HI 1053D	DIN
HI 1050S	Screw Cap
HI 1053P	BNC + PIN*

* For pH meters with CAL CHECK™ system

HI 1083X	Connector
HI 1083B	BNC
HI 1083D	DIN
HI 1083P	BNC + PIN*

* For pH meters with CAL CHECK™ system

HI 1093X	Connector
HI 1093B	BNC

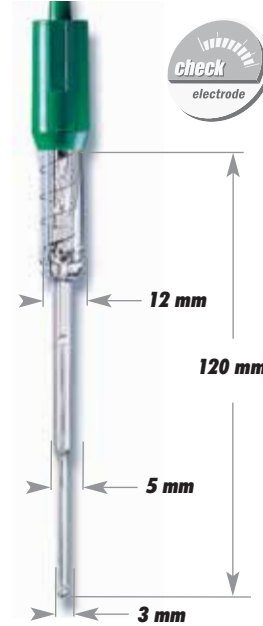
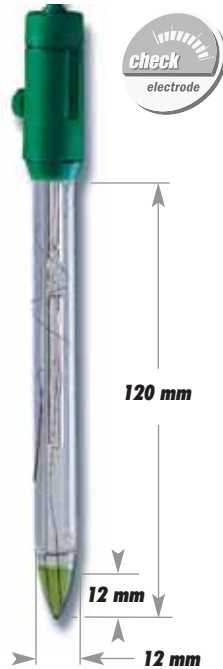
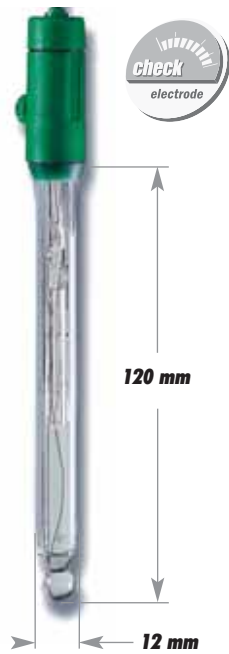

Code	HI 104XY	HI 105XY	HI 1083X	HI 1093X
Description	Refillable, combination pH electrode with double junction	Refillable, combination pH electrode with conical bulb	Refillable, combination pH electrode with micro bulb for small samples	Refillable, combination pH electrode with extended length & micro bulb
Reference	Double, Ag/AgCl	Single, Ag/AgCl	Single, Ag/AgCl	Single, Ag/AgCl
Junction / Flow Rate	Ceramic, single / 15-20 µL/H	Ceramic, triple / 40-50 µL/H	Open	Open
Electrolyte	KCl 3.5M	KCl 3.5M + AgCl	Viscolene	Viscolene
Max Pressure	0.1 bar	0.1 bar	0.1 bar	0.1 bar
Range	pH: 0 to 14 T: 0 to 100°C (32 to 212°F)	pH: 0 to 12 T: -5 to 100°C (23 to 212°F)	pH: 0 to 13 T: 0 to 50°C (32 to 122°F)	pH: 0 to 13 T: -5 to 50°C (23 to 122°F)
Tip /Shape	Spheric (dia: 9.5 mm)	Conic (12 x 12 mm)	Spheric (dia: 3 mm)	Spheric (dia: 3 mm)
Temperature Sensor	No	No	No	No
Amplifier	No	No	No	No
Body Material	Glass	Glass	Glass	Glass
Cable	Coaxial; 1 m (3.3)**	Coaxial; 1 m (3.3)**	Coaxial; 1 m (3.3)**	Coaxial; 1 m (3.3')
Recommended Use	Hydrocarbon, paints, solvents, sea water, strong acid and base, high conductivity samples, Tris buffer	Fats and creams, soil samples, potable water, semi solid products, low conductivity solutions, emulsions	Biotechnology, samples < 100 µl	NMR tubes

** Not for models with screw cap.

Recommended Operating Temperature
30 to 85°C (104 to 185°F)

Recommended Operating Temperature
-5 to 30°C (23 to 86°F)

Recommended Operating Temperature
20 to 40°C (86 to 104°F)

Recommended Operating Temperature
20 to 40°C (86 to 104°F)

Combination pH and ORP Electrodes

pH and ORP Electrodes Designed and Manufactured by HANNA

HI 11X1Y	Connector
HI 1131B	BNC
HI 1131D	DIN
HI 1111S	Screw Cap
HI 1131P	BNC + PIN*

* For pH meters with CAL CHECK™ system

HI 1135X	Connector
HI 1135B	BNC

HI 1143X	Connector
HI 1143B	BNC
HI 1143D	DIN

HI 1144X	Connector
HI 1144B	BNC
HI 1144D	DIN

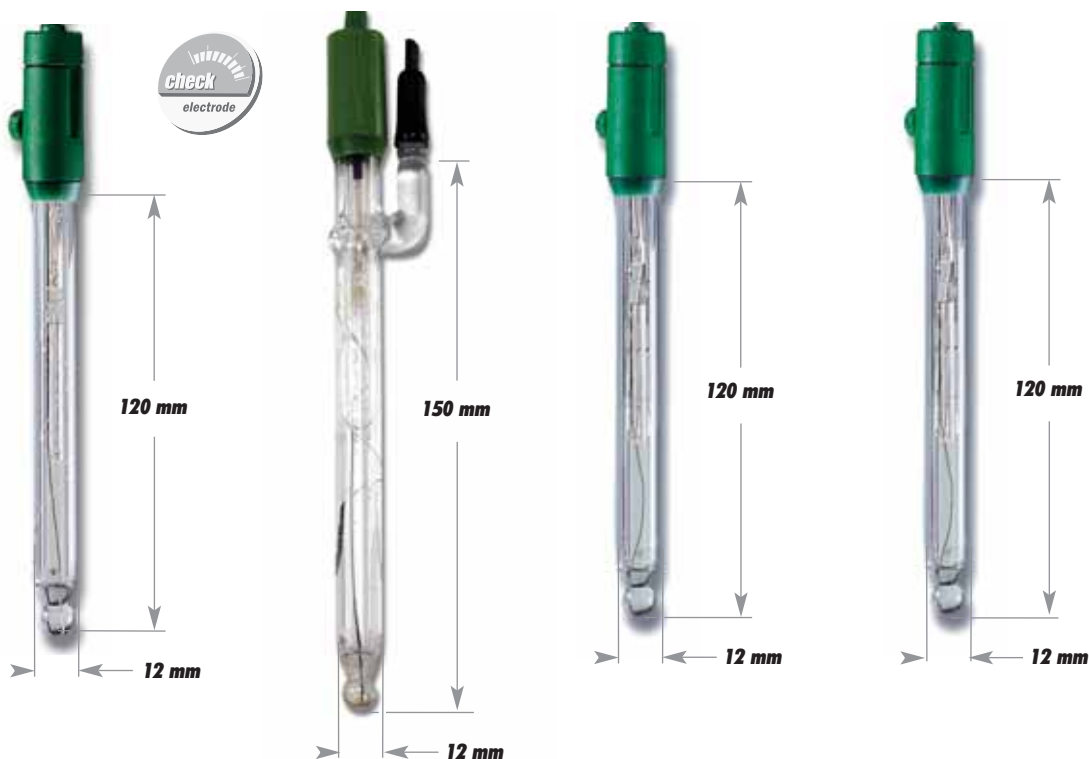

Code	HI 11X1Y	HI 1135X	HI 1143X	HI 1144X
Description	Refillable, combination pH electrode	Refillable, combination pH electrode side arm construction & fast flow rate	Refillable, combination pH electrode used for applications containing fluoride	Refillable, combination pH electrode with calomel references
Reference	Single, Ag/AgCl	Double, Ag/AgCl	Double, Ag/AgCl	Single, Hg/Hg ₂ Cl ₂
Junction / Flow Rate	Ceramic, single / 15-20 μL/H	Ceramic, double / 40-50 μL/H	Ceramic, single / 15-20 μL/H	Ceramic
Electrolyte	KCl 3.5M + AgCl	KCl 3.5M	KCl 3.5M	KCl 3.5M
Max Pressure	0.1 bar	3 bar with back pressure	0.1 bar	0.1 bar
Range	pH: 0 to 13 T: -5 to 100°C (23 to 212°F)	pH: 0 to 14 T: -5 to 100°C (23 to 212°F)	pH: 0 to 10 T: -5 to 60°C (23 to 140°F)	pH: 0 to 14 T: 0 to 60°C (32 to 140°F)
Tip /Shape	Spheric (dia: 9.5 mm)	Spheric (dia: 9.5 mm)	Spheric (dia: 9.5 mm)	Spheric (dia: 9.5 mm)
Temperature Sensor	No	No	No	No
Amplifier	No	No	No	No
Body Material	Glass	Glass	Glass	Glass
Cable	Coaxial; 1 m (3.3)**	Coaxial; 1 m (3.3)	Coaxial; 1 m (3.3)	Coaxial; 1 m (3.3)
Recommended Use	Laboratory general purpose, beer	Continuous monitoring with remote filling	Samples with fluoride (max 2 g/L @ pH 2 and temperature < 60°C)	Tris buffer

** Not for models with screw cap.

Recommended Operating Temperature 20 to 40°C (86 to 104°F)

Recommended Operating Temperature 30 to 85°C (104 to 185°F)

Recommended Operating Temperature -5 to 30°C (23 to 86°F)

Recommended Operating Temperature 20 to 40°C (86 to 104°F)

Combination pH and ORP Electrodes

pH and ORP Electrodes Designed and Manufactured by HANNA

HI 12X0Y	Connector
HI 1230B	BNC
HI 1230D	DIN
HI 1210S	Screw Cap

HI 13X1Y	Connector
HI 1331B	BNC
HI 1331D	DIN
HI 1311S	Screw Cap

HI 13X0Y	Connector
HI 1330B	BNC
HI 1330D	DIN
HI 1310S	Screw Cap
HI 1330P	BNC + PIN*

HI 1343X	Connector
HI 1343B	BNC
HI 1343D	DIN

* For pH meters with CAL CHECK™ system

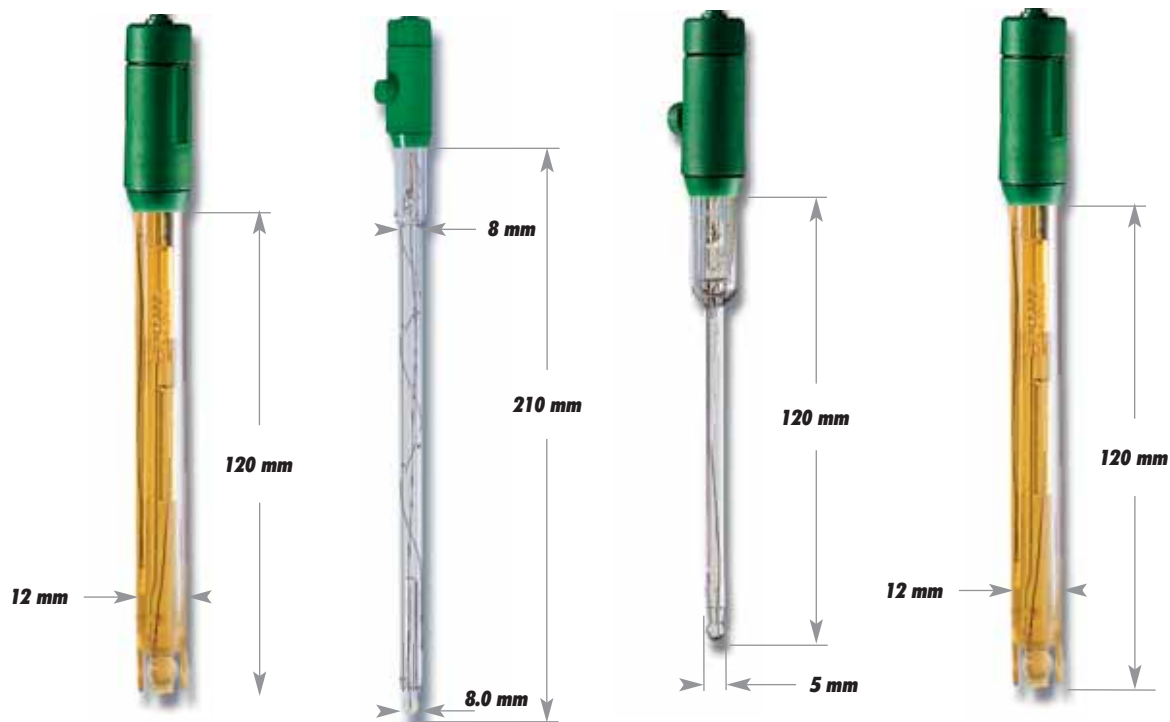

Code	HI 12X0Y	HI 13X1Y	HI 13X0Y	HI 1343Y
Description	combination pH electrode	combination pH electrode	combination pH electrode	combination pH electrode
Reference	Double, Ag/AgCl	Single, Ag/AgCl	Single, Ag/AgCl	Single, Hg/Hg ₂ Cl ₂
Junction / Flow Rate	Ceramic, single / 15-20 μL/H	Ceramic, single / 15-20 μL/H	Ceramic, single / 15-20 μL/H	Ceramic, single / 15-20 μL/H
Electrolyte	Gel	KCl 3.5M + AgCl	KCl 3.5M + AgCl	KCl 3.5M
Max Pressure	2 bar	0.1 bar	0.1 bar	0.1 bar
Range	pH: 0 to 13 T: 0 to 80°C (32 to 176°F)	pH: 0 to 13 T: -5 to 100°C (23 to 212°F)	pH: 0 to 13 T: -5 to 100°C (23 to 212°F)	pH: 0 to 14 T: -5 to 60°C (23 to 140°F)
Tip /Shape	Spheric (dia: 7.5 mm)	Spheric (dia: 7.5 mm)	Spheric (dia: 5 mm)	Spheric (dia: 7.5 mm)
Temperature Sensor	No	No	No	No
Amplifier	No	No	No	No
Body Material	PEI	Glass	Glass	PEI
Cable	Coaxial; 1 m (3.3)**	Coaxial; 1 m (3.3)**	Coaxial; 1 m (3.3)**	Coaxial; 1 m (3.3)
Recommended Use	Field applications	Specific for flasks	Specific for vials and test tubes	Specific for Tris buffer

** Not for models with screw cap.

Recommended Operating Temperature 20 to 40°C (86 to 104°F)

Recommended Operating Temperature 20 to 40°C (86 to 104°F)

Recommended Operating Temperature 20 to 40°C (86 to 104°F)

Recommended Operating Temperature 20 to 40°C (86 to 104°F)

Combination pH and ORP Electrodes

pH and ORP Electrodes Designed and Manufactured by HANNA



"...a pH meter that helps you to follow strict procedures"

Mrs. L. Paalvast

Company: Mediq Jan Heyns
Bereidingsapotheek, the Netherlands
Medicine producer for 5 pharmacies.

HI 20XYZ	Connector
HI 2031B	BNC
HI 2031D	DIN
HI 2020S	Screw Cap

HI 3118X	Connector
HI 3118B	BNC

HI 31X1Y	Connector
HI 3131B	BNC
HI 3131D	DIN
HI 3111S	Screw Cap
HI 3131P	BNC + PIN*

* For pH meters with CAL CHECK™ system

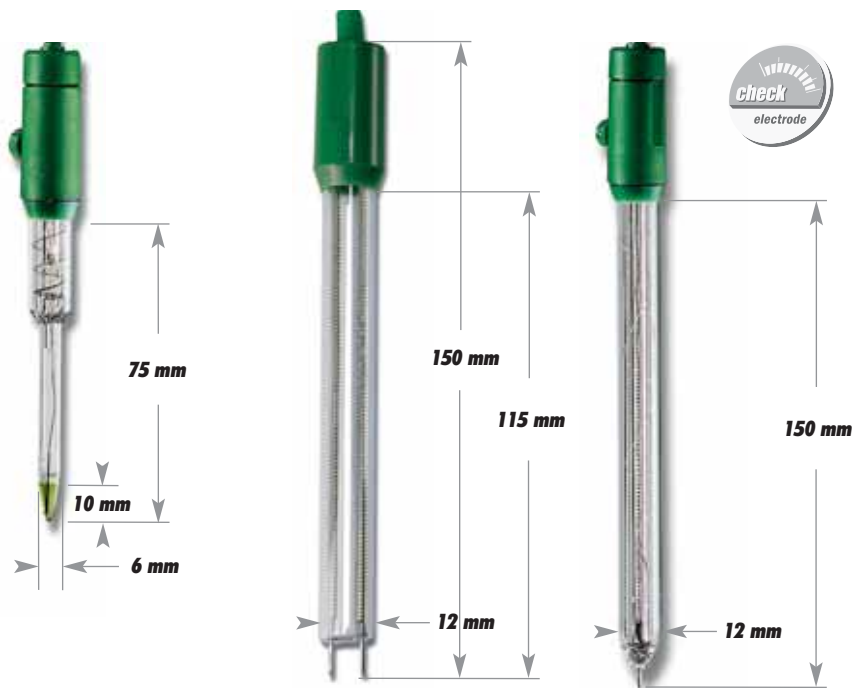

Code	HI 20XYZ	HI 3118X	HI 31X1Y
Description	Refillable, spear tip combination pH electrode	Dual platinum electrode for amperometric titration	Refillable combination ORP electrode
Reference	Single, Ag/AgCl	—	Single, Ag/AgCl
Amperometric Cell	—	Platinum-Platinum	—
Junction / Flow Rate	Ceramic, single / 15-20 µL/H	—	Ceramic, single / 15-20 µL/H
Electrolyte	KCl 3.5M + AgCl	—	KCl 3.5M + AgCl
Max Pressure	0.1 bar	—	0.1 bar
Range	pH: 0 to 12 T: -5 to 100°C (23 to 212°F)	T: -5 to 100°C (23 to 212°F)	ORP T: -5 to 100°C (23 to 212°F)
Tip /Shape	Conic (6 x 10 mm)	2-pin platinum	Platinum pin
Temperature Sensor	No	—	No
Amplifier	No	—	No
Body Material	Glass	Glass	Glass
Cable	Coaxial; 1 m (3.3)**	Bipolar	Coaxial; 1 m (3.3)**
Recommended Use	Dairy and semi solid products	Chlorine titration ASTM D 1253-86	Laboratory general use, ORP titrations

** Not for models with screw cap.

Recommended Operating Temperature
-5 to 30°C (23 to 86°F)

Recommended Operating Temperature
20 to 40°C (86 to 104°F)

Recommended Operating Temperature
20 to 40°C (86 to 104°F)

Special ORP Electrodes

with Amplified Electrodes with Platinum or Gold Tips

HI 3618X	Connector
HI 3618D	DIN

HI 3620X	Connector
HI 3620D	DIN

HI 4619X	Connector
HI 4619D	DIN

ORP measurements are used as an effective measure of the sanitation of pool, spa and potable water. *E. Coli* bacteria presence in water depends on the ORP value. ORP is a reliable indicator of bacteriological water quality.

Installing and checking the electrode

ORP electrodes can be used on any HANNA pH/ORP meter.

1) After removing the protective cap from the electrode and opening the fill hole cover, soak the tip in warm tap water. This will enhance the flow of the reference junction.

2) To check the function of the electrode, immerse the tip in HI 7020 ORP test solution (HI 7020). The value should be between 200 and 275 mV. Oxidizing or reduction treatment with HI 7092 or HI 7091 will prepare the electrode's surface and speed initial response time.

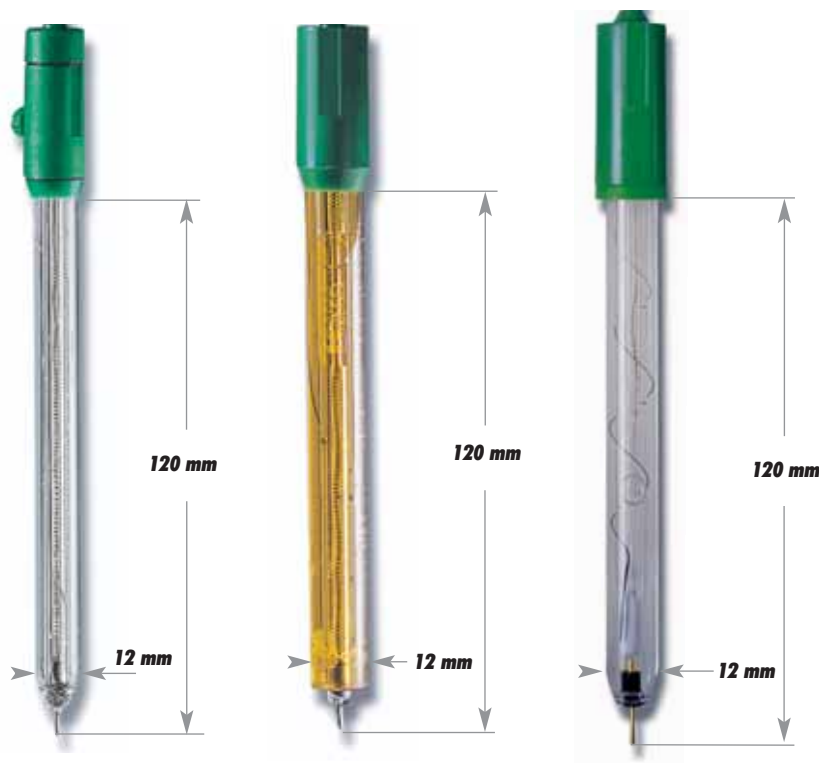

Code	HI 3618X	HI 3620X	HI 4619X
Description	ORP electrode	ORP electrode	ORP electrode
Reference	Single, Ag/AgCl	Single, Ag/AgCl	Single, Ag/AgCl
Junction / Flow Rate	Ceramic, single / 15-20 µL/H	Ceramic, single / 15-20 µL/H	Ceramic, triple / 40-50 µL/H
Electrolyte	KCl 3.5M + AgCl	Gel	Gel
Max Pressure	0.1 bar	2 bar	2 bar
Range	ORP: ±2000 mV T: -5 to 100°C (23 to 212°)	ORP: ±2000 mV T: 0 to 80°C (32 to 176°F)	ORP: ±2000 mV T: -5 to 100°C (23 to 212°)
Tip /Shape	Platinum pin	Platinum pin	Gold pin
Temperature Sensor	Yes	No	Yes
Amplifier	Yes	Yes	Yes
Body Material	Glass	PEI	Glass
Cable	5-pole; 1 m (3.3')	7-pole; 1 m (3.3')	5-pole; 1 m (3.3')
Recommended Use	Laboratory	Field applications, swimming pools	Strong oxidants, disinfection with ozone

Recommended Operating Temperature
20 to 40°C (86 to 104°F)

Recommended Operating Temperature
20 to 40°C (86 to 104°F)

Recommended Operating Temperature
20 to 40°C (86 to 104°F)

pH Electrodes with Temperature Sensor

pH Electrodes with Temperature Measurement Capability

HI 1610X	Connector
HI 1610D	DIN

HI 1611X	Connector
HI 1611D	DIN

HI 1612X	Connector
HI 1612D	DIN

FC 211X	Connector
FC 211D	DIN

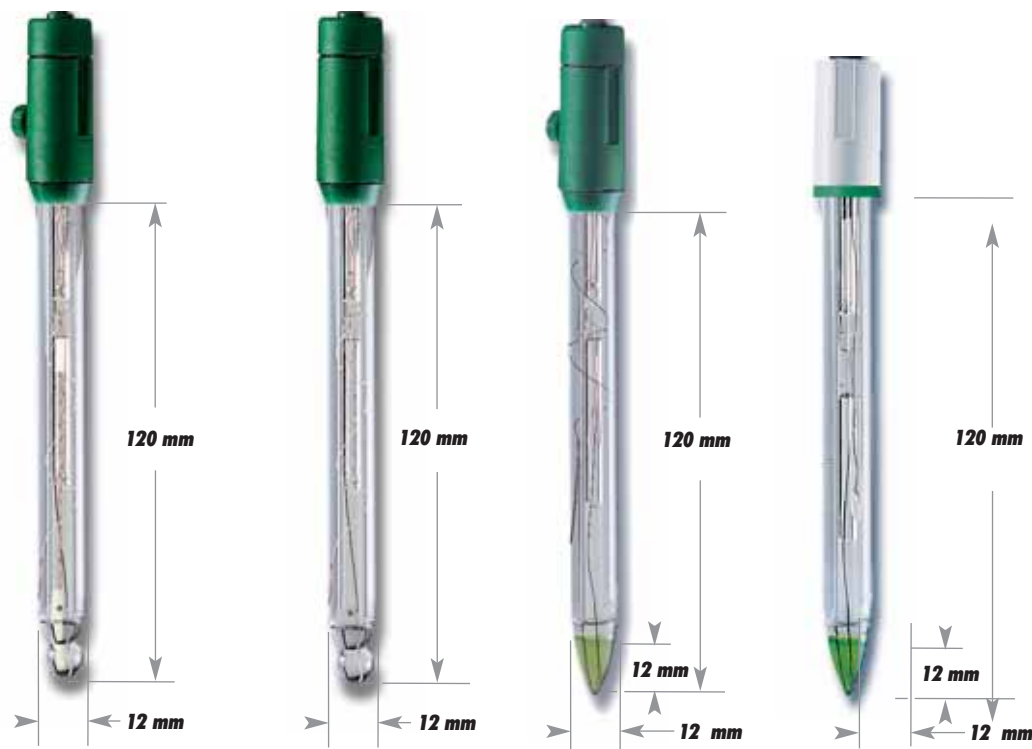

Code	HI 1610X	HI 1611X	HI 1612X	FC 211X
Description	pH electrode	pH electrode	pH electrode	pH electrode
Reference	Single, Ag/AgCl	Single, Ag/AgCl	Single, Ag/AgCl	Single, Ag/AgCl
Junction / Flow Rate	Ceramic, single / 15-20 µL/H	Ceramic, single / 15-20 µL/H	Ceramic, triple / 40-50 µL/H	Open
Electrolyte	KCl 3.5M + AgCl	Gel	KCl 3.5M + AgCl	Viscolene
Max Pressure	0.1 bar	2 bar	0.1 bar	0.1 bar
Range	pH: 0 to 13 T: -5 to 100°C (23 to 212°F)	pH: 0 to 14 T: 0 to 100°C (32 to 212°F)	pH: 0 to 12 T: -5 to 100°C (23 to 212°F)	pH: 0 to 12 T: 0 to 50°C (32 to 122°F)
Tip /Shape	Spheric (dia: 9.5 mm)	Spheric (dia: 9.5 mm)	Conic (12 x 12 mm)	Conic (12 x 12 mm)
Temperature Sensor	Yes	Yes	Yes	Yes
Amplifier	Yes	Yes	Yes	Yes
Body Material	Glass	Glass	Glass	Glass
Cable	5-pole; 1 m (3.3')	5-pole; 1 m (3.3')	5-pole; 1 m (3.3')	5-pole; 1 m (3.3')
Recommended Use	Laboratory general use	Continuous monitoring	Emulsions, semi solid samples	Milk, yogurt, cream

Recommended Operating Temperature
20 to 40°C (86 to 104°F)

Recommended Operating Temperature
30 to 85°C (104 to 185°F)

Recommended Operating Temperature
-5 to 30°C (23 to 86°F) +
20 to 40°C (86 to 104°F)

Recommended Operating Temperature
-5 to 30°C (23 to 86°F)

Rugged

pH and ORP Electrodes

Designed for General Use

HI 13X2Y	Connector
HI 1332B	BNC
HI 1332D	DIN
HI 1312S	Screw Cap
HI 1332P	BNC + PIN*

* For pH meters with CAL CHECK™ system

HI 32X0Y	Connector
HI 3230B	BNC
HI 3230D	DIN
HI 3210S	Screw Cap

HI 44X0Y	Connector
HI 4430B	BNC
HI 4430D	DIN
HI 4410S	Screw Cap

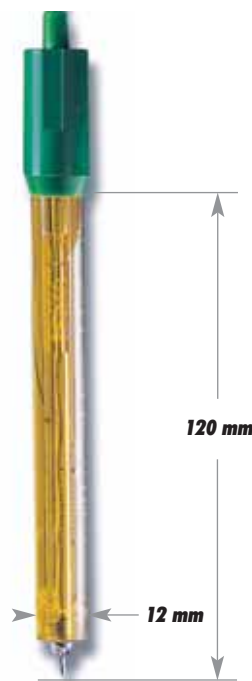

Code	HI 13X2Y	HI 32X0Y	HI 44X0Y
Description	pH electrode	ORP electrode	Gel filled, combination ORP electrode with gold contact
Reference	Double, Ag/AgCl	Single, Ag/AgCl	Single, Ag/AgCl
Junction / Flow Rate	Ceramic, single / 15-20 µL/H	Ceramic, single / 15-20 µL/H	Ceramic, single / 15-20 µL/H
Electrolyte	KCl 3.5M	Gel	Gel
Max Pressure	0.1 bar	2 bar	2 bar
Range	pH: 0 to 13 T: 0 to 80°C (32 to 176°F)	ORP: ±2000 mV T: 0 to 80°C (32 to 176°F)	ORP: ±2000 mV T: 0 to 80°C (32 to 176°F)
Tip /Shape	Spheric (dia: 7.5 mm)	Platinum pin	Gold pin
Temperature Sensor	No	No	No
Amplifier	No	No	No
Body Material	PEI	PEI	PEI
Cable**	Coaxial; 1 m (3.3')	Coaxial; 1 m (3.3')	Coaxial; 1 m (3.3')
Recommended Use	Chemicals, field applications, quality control	Municipal water, quality control	Oxidants, ozone

** Not for models with screw cap.

Recommended Operating Temperature
20 to 40°C (86 to 104°F)

Recommended Operating Temperature
20 to 40°C (86 to 104°F)

Recommended Operating Temperature
20 to 40°C (86 to 104°F)

Special Application Electrodes

Electrodes to Perform a Specific Analysis

HI 1297X	Connector
HI 1297D	DIN*

* To be used with **HI 991002** and **HI 991003**

HI 1413X	Connector
HI 1413B	BNC

HI 1413X/50	Conn.
HI 1413B/50	BNC ^{††}
HI 1413S/50	Screw Cap ^{††}

^{††} To be used with **Skincheck™** series

HI 1414X	Connector
HI 1414D	DIN [†]

[†] To be used with **HI 99171**

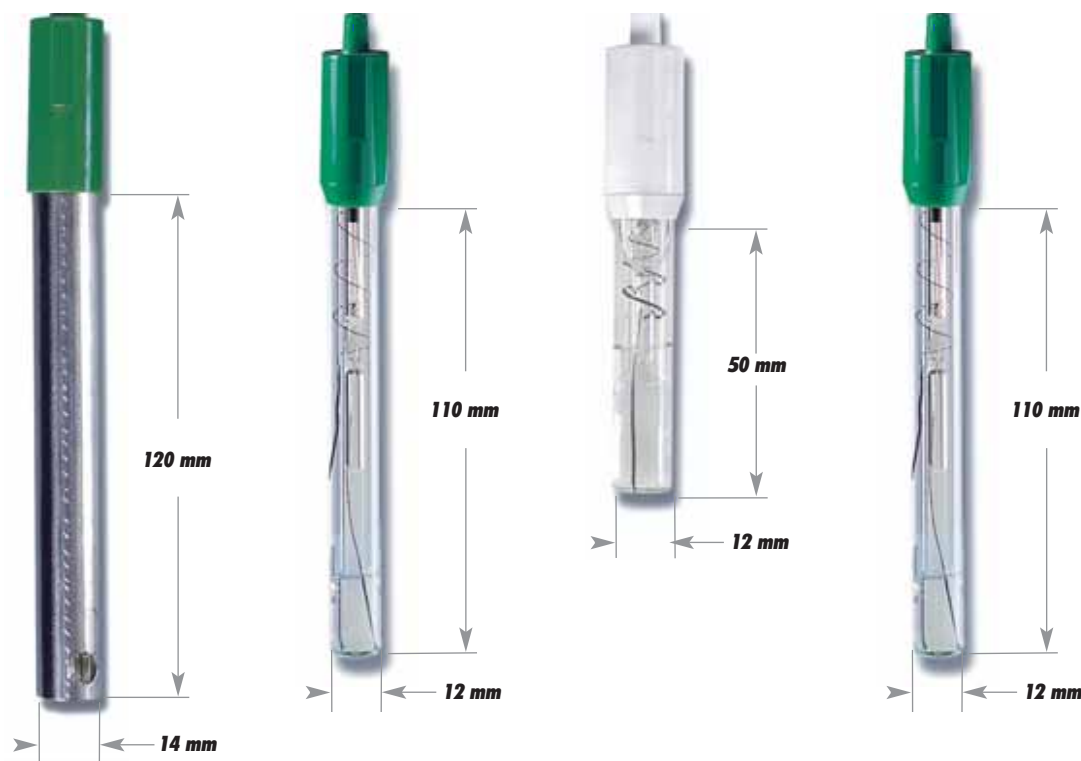

Code	HI 1297X	HI 1413X	HI 1413X/50	HI 1414X
Description	pH/ORP electrode with titanium cage	pH electrode	pH electrode	pH electrode
Reference	Single, Ag/AgCl	Single, Ag/AgCl	Single, Ag/AgCl	Single, Ag/AgCl
Junction	Cloth	Open	Open	Open
Electrolyte	Gel	Viscolene	Viscolene	Viscolene
Max Pressure	3 bar	0.1 bar	0.1 bar	0.1 bar
Range	pH: 0 to 13; ORP T: 0 to 80°C (32 to 176°F)	pH: 0 to 12 T: -5 to 50°C (23 to 122°F)	pH: 0 to 12 T: -5 to 50°C (23 to 122°F)	pH: 0 to 12 T: -5 to 50°C (23 to 122°F)
Tip /Shape	pH: Conic (3 mm) ORP: Platinum sensor	Flat	Flat	Flat
Temperature Sensor	Yes	No	No	Yes
Amplifier	Yes	No	No	Yes
Body Material	Titanium cage	Glass	Glass	Glass
Cable**	7-pole; 1 m (3.3')	Coaxial; 1 m (3.3')	Coaxial; 1 m (3.3')	7-pole; 1 m (3.3')
Recommended Use	Wastewater, municipal water, water treatment, swimming pools	Surfaces, skin, leather, paper, emulsions	Skin, scalp	Surface, leather, paper, emulsions

** Not for models with screw cap.

Recommended Operating Temperature 20 to 40°C (86 to 104°F)

Recommended Operating Temperature 20 to 40°C (86 to 104°F)

Recommended Operating Temperature 20 to 40°C (86 to 104°F)

Recommended Operating Temperature 20 to 40°C (86 to 104°F)

Food Industry Specific Electrodes

Designed for Laboratories, Food Processing, Goods-in Areas and Service Industries

FC 100X	Connector
FC 100B	BNC
FC 100D	DIN

FC 200X	Connector
FC 200B	BNC
FC 200D	DIN
FC 200S	Screw Cap

FC 210X	Connector
FC 210B	BNC
FC 210D	DIN

FC 220X	Connector
FC 220B	BNC
FC 220D	DIN

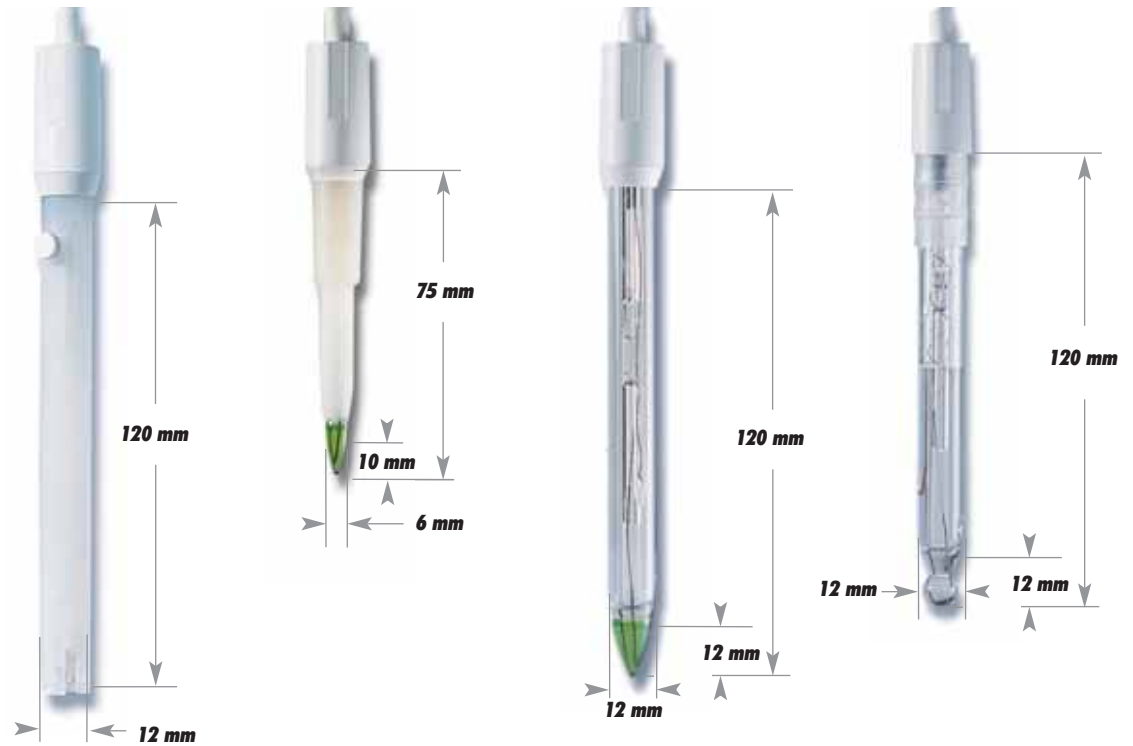

Code	FC 100X	FC 200X	FC 210X	FC 220X
Description	pH electrode	pH electrode	pH electrode	pH electrode
Reference	Double, Ag/AgCl	Single, Ag/AgCl	Double, Ag/AgCl	Single, Ag/AgCl
Junction / Flow Rate	Ceramic, single / 15-20 µL/H	Open	Open	Ceramic, triple / 40-50 µL/H
Electrolyte	KCl 3.5M	Viscolene	Viscolene	KCl 3.5M + AgCl
Max Pressure	0.1 bar	0.1 bar	0.1 bar	0.1 bar
Range	pH: 0 to 13 T: 0 to 80°C (32 to 176°F)	pH: 0 to 12 T: 0 to 50°C (32 to 122°F)	pH: 0 to 12 T: 0 to 50°C (32 to 122°F)	pH: 0 to 12 T: 0 to 100°C (32 to 212°F)
Tip /Shape	Spheric (dia: 7.5 mm)	Conic (6 x 10 mm)	Conic (12 x 12 mm)	Spheric (dia: 9.5 mm)
Temperature Sensor	No	No	No	No
Amplifier	No	No	No	No
Body Material	PVDF	PVDF	Glass	Glass
Cable**	Coaxial; 1 m (3.3')	Coaxial; 1 m (3.3')	Coaxial; 1 m (3.3')	Coaxial; 1 m (3.3')
Recommended Use	Cheese	Milk, yogurt, dairy products, semi solid foods	Milk, yogurt, creams	Creams, fruit juices, sauces

** Not for models with screw cap.

Recommended Operating Temperature 20 to 40°C (86 to 104°F)

Recommended Operating Temperature -5 to 30°C (23 to 86°F)

Recommended Operating Temperature 20 to 40°C (86 to 104°F)

Recommended Operating Temperature -5 to 30°C (23 to 86°F) + 20 to 40°C (86 to 104°F)

Food Industry Specific Electrodes

Designed for Laboratories, Food Processing, Goods-in Areas and Service Industries

FC 230X	Connector
FC 230B	BNC
FC 230D	DIN

FC 240X	Connector
FC 240B	BNC

FC 250X	Connector
FC 250B	BNC

FC 300X	Connector
FC 300B	BNC
FC 300D	DIN

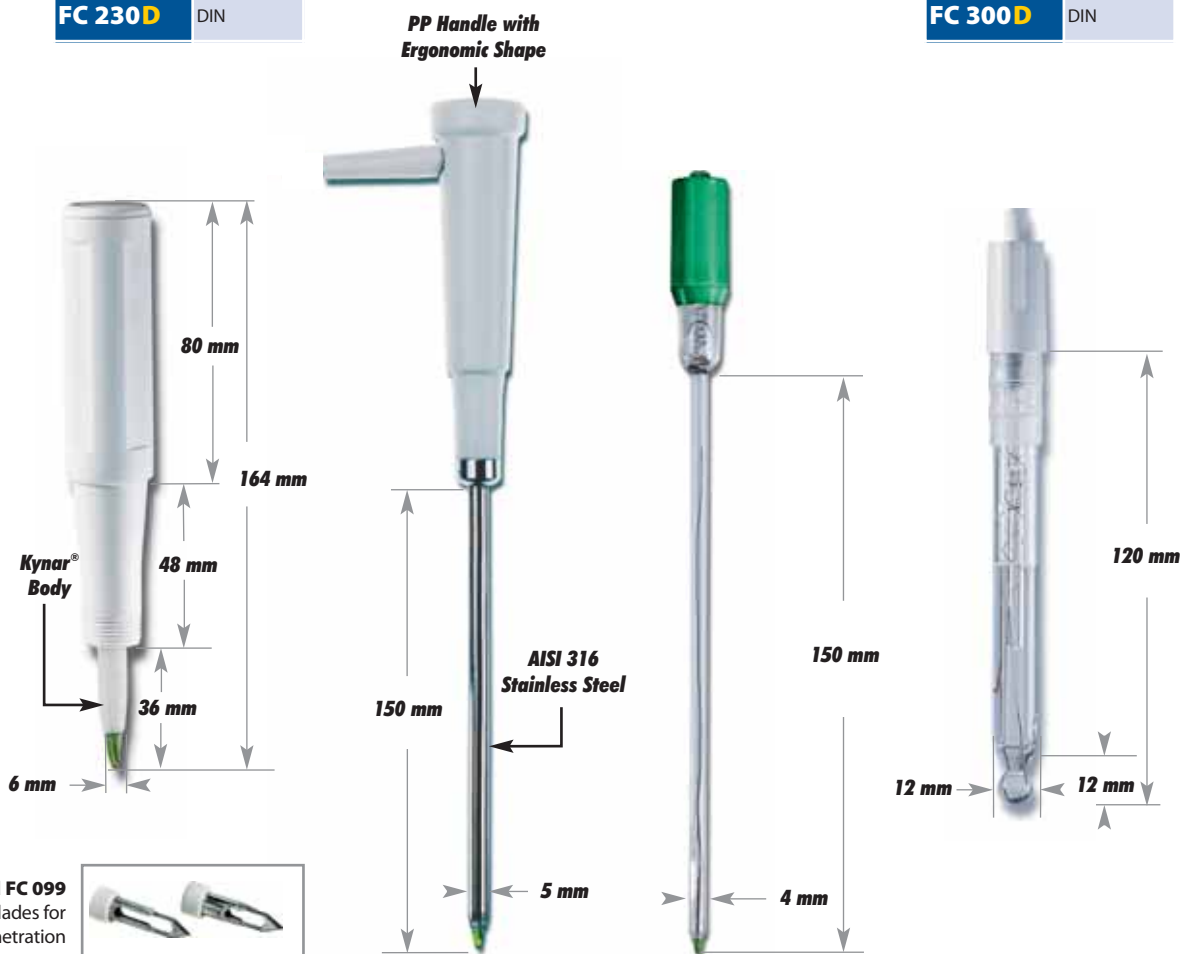

FC 098 and FC 099
stainless steel blades for
meat penetration

Code	FC 230X	FC 240X	FC 250X	FC 300X
Description	Combination pH electrode with PVDF outer body	Combination pH electrode with stainless steel sheath	Combination pH electrode with long, thin body	Combination sodium ion electrode
Reference	Single, Ag/AgCl	Single, Ag/AgCl	Double, Ag/AgCl	Single, Ag/AgCl
Junction / Flow Rate	Open	Open	Open	Ceramic, triple / 40-50 µL/H
Electrolyte	Viscolene	Viscolene	Viscolene	KCl 3.5M + AgCl
Max Pressure	0.1 bar	0.1 bar	0.1 bar	0.1 bar
Range	pH: 0 to 12 T: 0 to 50°C (32 to 122°F)	pH: 0 to 13 T: 0 to 50°C (32 to 122°F)	pH: 0 to 13 T: 0 to 50°C (32 to 122°F)	Na ⁺ : 10 ⁻⁴ to 3x10 ³ g/L / T: 0 to 100°C (32 to 212°F)
Tip /Shape	Conic (6 x 10 mm)	Conic (3 x 5 mm)	Conic (3 x 5 mm)	Spheric (dia: 9.5 mm)
Temperature Sensor	No	No	No	No
Amplifier	No	No	No	No
Body Material	PVDF	AISI 316	Glass	Glass
Cable	Coaxial; 1 m (3.3')	Coaxial; 1 m (3.3')	Coaxial; 1 m (3.3')	Coaxial; 1 m (3.3')
Recommended Use	Meat, semi frozen products	Dairy products, cheese quality control	Dairy products, semi mature cheese	Food products, laboratory

Recommended Operating Temperature
-5 to 30°C (23 to 86°F)

Recommended Operating Temperature
20 to 40°C (86 to 104°F)

Recommended Operating Temperature
20 to 40°C (86 to 104°F)

Recommended Operating Temperature
20 to 40°C (86 to 104°F)

Food Industry Specific Electrodes

Designed for Laboratories, Food Processing, Goods-in Areas and Service Industries

FC 301 X	Connector
FC 301 B	BNC

FC 400 X	Connector
FC 400 B	BNC
FC 400 D	DIN

HI 1048 X	Connector
HI 1048 B	BNC
HI 1048 D	DIN
HI 1048 P	BNC + PIN*

HI 1153 X	Connector
HI 1153 B	BNC
HI 1153 D	DIN

* To be used with **HI 222** pH meter with CAL CHECK™ system

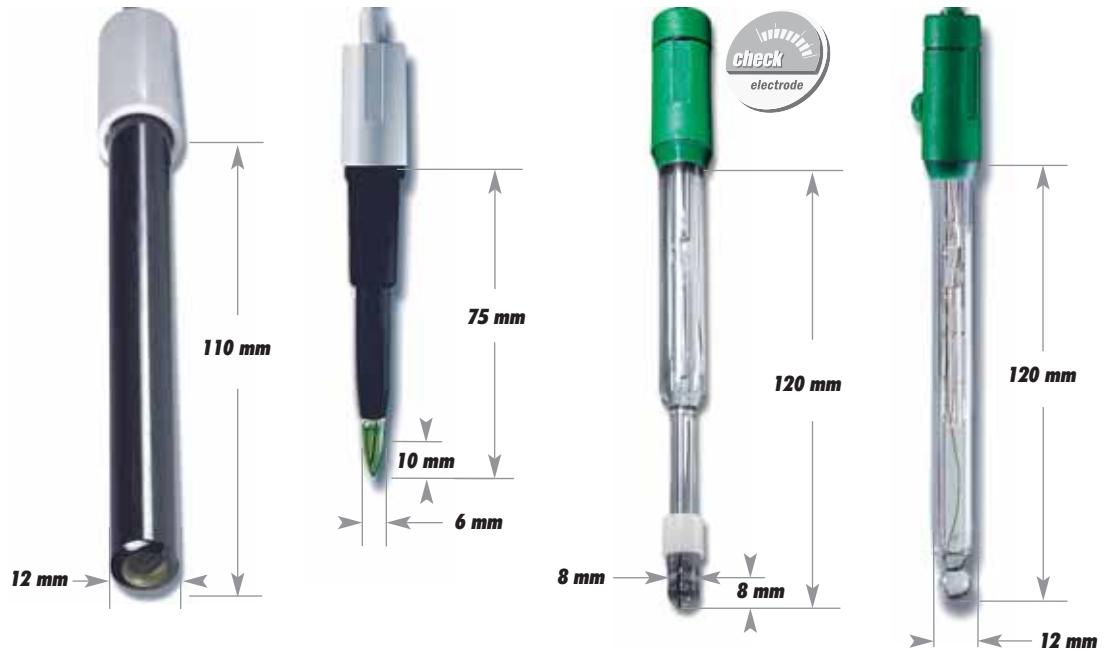

Code	FC 301X	FC 400X	HI 1048X	HI 1153X
Description	Fluoride electrode	pH electrode	pH electrode with Clogging Prevention System (CPS™)	pH electrode
Reference	—	Single, Ag/AgCl	Double, Ag/AgCl	Double, Ag/AgCl
Junction / Flow Rate	—	Open	Open, CPS™	Ceramic, triple / 40-50 µL/H
Electrolyte	—	Viscolene	KCl 3.5M	KCl 3.5M
Max Pressure	0.1 bar	0.1 bar	0.1 bar	0.1 bar
Range	Fluoride: 10 ⁻⁶ to saturation / T: -5 to 35°C (23 to 95°F)	pH: 0 to 12 T: 0 to 50°C (32 to 122°F)	pH: 0 to 13 T: -5 to 80°C (23 to 176°F)	pH: 0 to 13 T: 0 to 100°C (32 to 212°F)
Tip /Shape	Flat	Conic (3 x 5 mm)	Spheric (dia: 8 mm)	Spheric (dia: 9.5 mm)
Temperature Sensor	No	No	No	No
Amplifier	No	No	No	No
Body Material	PEI	PVDF	Glass	Glass
Cable	Coaxial; 1 m (3.3')	Coaxial; 1 m (3.3')	Coaxial; 1 m (3.3')	Coaxial; 1 m (3.3')
Recommended Use	Wastewater, heavy-duty applications, glass production, electronic industry	Meat	Wine, must	Mineral water

Recommended Operating Temperature
20 to 40°C (86 to 104°F)

Recommended Operating Temperature
-5 to 30°C (23 to 86°F) +
20 to 40°C (86 to 104°F)

Recommended Operating Temperature
20 to 40°C (86 to 104°F)

Recommended Operating Temperature
20 to 40°C (86 to 104°F)

pH Half Cells

Designed and Created by the Manufacturer ... HANNA instruments®

HI 2110X	Connector
HI 2110B	BNC

HI 2112X	Connector
HI 2112B	BNC

HI 2111X	Connector
HI 2111B	BNC

HI 3133X	Connector
HI 3133B	BNC

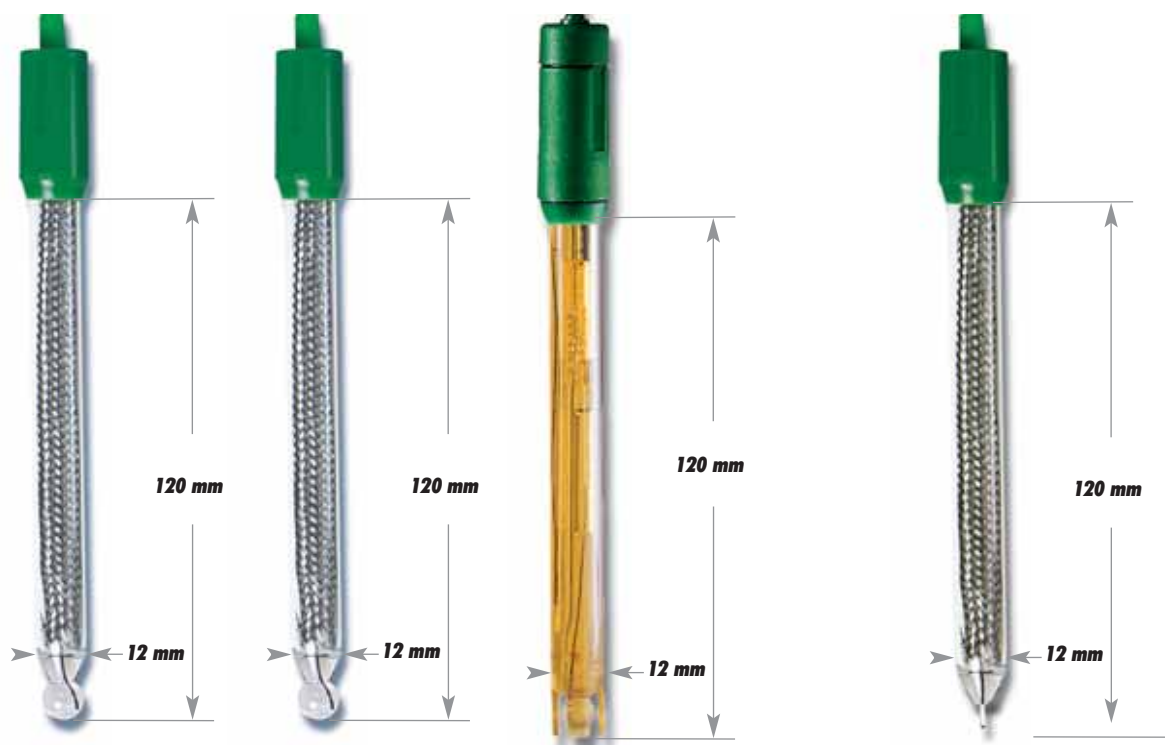

Code	HI 2110X	HI 2111X	HI 2112X
Description	pH half-cell	pH half-cell	pH half-cell
pH Half Cell	—	—	—
Range	pH: 0 to 12 T: -5 to 80°C (23 to 176°F)	pH: 0 to 14 T: 0 to 100°C (32 to 212°F)	pH: 0 to 13 T: -5 to 80°C (23 to 176°F)
Tip /Shape	Spheric (dia: 9.5 mm)	Spheric (dia: 9.5 mm)	Spheric (dia: 7.5 mm)
Body Material	Glass	Glass	PEI
Cable	Coaxial	Coaxial	Coaxial
Recommended Use	Titration	General purpose, strong alkaline solutions	General purpose

Code	HI 3133X
Description	ORP half-cell
ORP Half Cell	Platinum
Range	mV T: -5 to 80°C (23 to 176°F)
Tip /Shape	Platinum pin
Body Material	Glass
Cable	Coaxial
Recommended Use	General purpose, potentiometric titration

Recommended Operating Temperature
-5 to 30°C (23 to 86°F)

Recommended Operating Temperature
30 to 85°C (104 to 185°F)

Recommended Operating Temperature
20 to 40°C (86 to 104°F)

Recommended Operating Temperature
20 to 40°C (86 to 104°F)

ORP Half Cells

Reference Electrodes

Double and Single Reference Electrodes

HI 5110X	Connector
HI 5110B	BNC

HI 5412	Connector
HI 5412	4 mm Banana

HI 5414	Connector
HI 5414	4 mm Banana

HI 5413	Connector
HI 5413	4 mm Banana

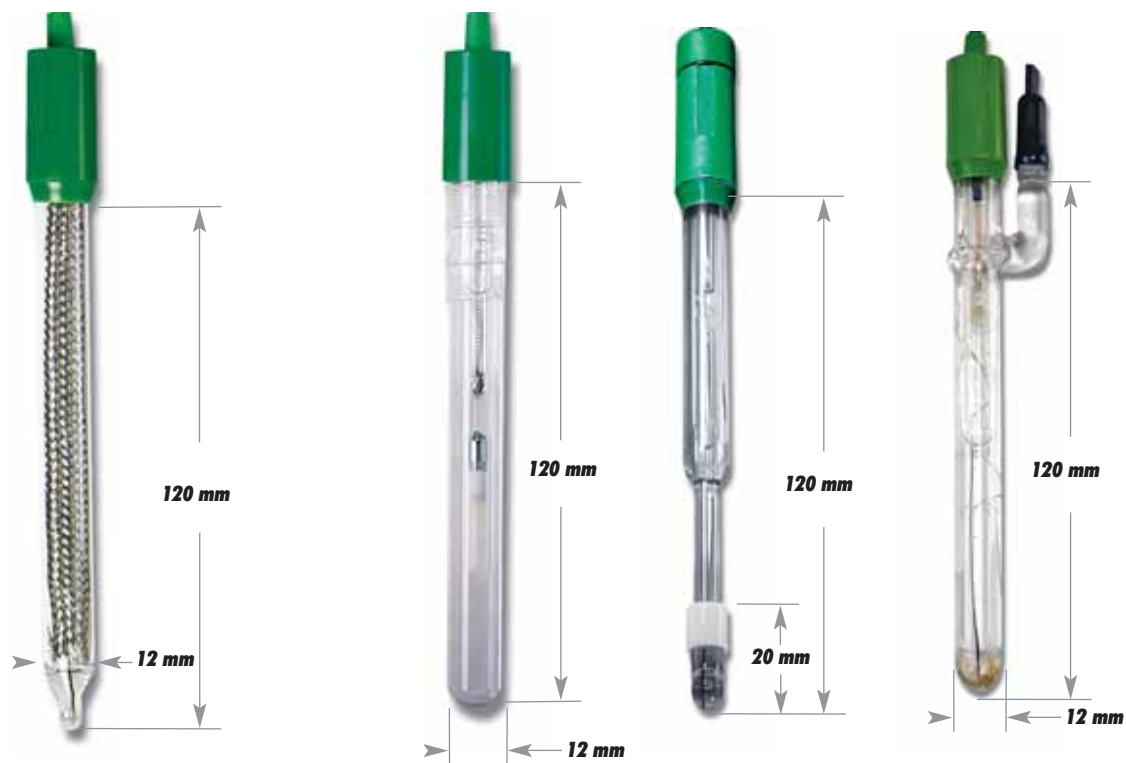

Code	HI 5110X
Description	ORP half-cell
ORP Half Cell	Ag
Range	mV T: -5 to 80°C (23 to 176°F)
Tip /Shape	Cylindric (dia: 3 mm)
Body Material	Glass
Cable	Coaxial
Recommended Use	Argentometric titration

Recommended Operating Temperature
20 to 40°C (86 to 104°F)

Code	HI 5412	HI 5413	HI 5414
Description	Reference electrode	Reference electrode	Reference electrode
Reference	Single, Hg/Hg ₂ Cl ₂	Single, Hg/Hg ₂ Cl ₂	Single, Hg/Hg ₂ Cl ₂
Junction/FlowRate	Ceramic, single / 15-20 µL/H	PTFE sleeve	Ceramic, double
Electrolyte	KCl 3.5M	KCl 3.5M	KCl 3.5M
Max Pressure	0.1 bar	0.1 bar	3 bar with back pressure
Range	T: -5 to 60°C (23 to 140°F)	T: -5 to 60°C (23 to 140°F)	T: -5 to 60°C (23 to 140°F)
Body Material	Glass	Glass	Glass
Cable	1 m (3.3')	1 m (3.3')	1 m (3.3')
Recommended Use	General purpose, ISE, titrations	Samples with suspended solids, ISE	Measurements with remote filling

Recommended Operating Temperature
-5 to 30°C (23 to 86°F)

Recommended Operating Temperature
-5 to 30°C (23 to 86°F) +
20 to 40°C (86 to 104°F)

Recommended Operating Temperature
-5 to 30°C (23 to 86°F)

High Pressure or High Concentration of Contaminants.

Because of the special electrode recharge system of the HI 5414, it is possible to connect an outside container to increase the amount of electrolyte of the reference half-cell and thus the pressure inside the electrode. By so doing, the junction will be able to work in high-pressure environments without the danger of implosion.



Reference Electrodes

Double and Single Reference Electrodes

HI 5311	Connector
HI 5311	4 mm Banana

HI 5312	Connector
HI 5312	4 mm Banana

HI 5313	Connector
HI 5313	4 mm Banana

HI 5314	Connector
HI 5314	4 mm Banana



Code	HI 5311	HI 5312	HI 5313	HI 5314
Description	Reference electrode	Reference electrode	Reference electrode	Reference electrode
Reference	Double, Ag/AgCl	Double, Ag/AgCl	Single, Ag/AgCl	Double, Ag/AgCl
Junction / Flow Rate	Ceramic, single / 15-20 µL/H	PTFE sleeve	Ceramic	Ceramic, double
Electrolyte	KCl 3.5M	KCl 3.5M	Gel (KCl 1M + AgCl)	KCl 3.5M
Max Pressure	0.1 bar	0.1 bar	0.1 bar	3 bar with back pressure
Range	T: -5 to 100°C (23 to 212°F)	T: -5 to 100°C (23 to 212°F)	T: -5 to 35°C (23 to 95°F)	T: -5 to 100°C (23 to 212°F)
Body Material	Glass	Glass	PEI	Glass
Cable	1 m (3.3')	1 m (3.3')	1 m (3.3')	1 m (3.3')
Recommended Use	General purpose (wide temperature range), titrations	Titrations, samples with suspended solids	Used with FC 301B	Measurements with remote filling

Recommended Operating Temperature
30 to 85°C (104 to 185°F)

Recommended Operating Temperature
-5 to 30°C (23 to 86°F) +
20 to 40°C (86 to 104°F)

Recommended Operating Temperature
-5 to 30°C (23 to 86°F)

Recommended Operating Temperature
30 to 85°C (104 to 185°F)

Ion Selective Electrodes

For HANNA's New Generation of Instruments

ISE Electrode Types

HANNA's ion selective electrodes can be grouped into three general categories based upon construction.



Solid State Electrodes are available as both single half-cells or as combination electrodes complete with reference electrode. These electrodes incorporate a solid sensing surface made of compressed silver halides, or solid crystalline material. HANNA's offering includes sensors for the determination of bromide, cadmium, chloride, cupric, cyanide, fluoride, iodide, lead and silver ions. Solid body construction is rugged for long life.

Theory: A solid state electrode develops a voltage due to ion-exchange occurring between the sample and the inorganic membrane. An equilibrium mechanism occurs due to the very limited solubility of the membrane material in the sample.

Liquid Membrane Electrodes are available as single half-cells or as combination electrodes complete with reference electrode. The sensing surfaces of these electrodes are comprised of a homogeneous polymer matrix containing organic ion-exchangers selective for the determined ion. These sensors incorporate easily replaceable membrane modules and are available for measurements of nitrate, potassium and calcium.

Theory: The potassium electrode was one of the earliest liquid membrane sensors developed of this type. The membrane is usually in the form of a thin disc of PVC impregnated with the antibiotic valinomycin. The exchanger, also known as an ionophore, is a ring structure that fits potassium ions inside like a lock and key. This type of membrane is not as rugged as the solid state type so they are designed for easy replacement of the sensing module.

Gas Sensors are combination electrodes that detect dissolved gases in a solution. No external reference is required for these electrodes. The sensing element is separated from the sample solution by a gas permeable membrane. HANNA's offering includes the HI 4101 Ammonia electrode and the HI 4105 Carbon Dioxide electrode.

Theory: A gas sensor works due to the partial pressure of the measured gas in solution. The dissolved gas in the sample diffuses into the membrane and changes the pH in a thin film of unbuffered electrolyte on the surface of the internal pH sensor. Diffusion continues until the partial pressure of the sample and the thin film is the same. The pH change is proportional to the dissolved gas in the sample.

Ion Selective Electrodes

For HANNA's New Generation of Instruments

Reference and Combination Electrodes

HANNA's reference electrode is used with our half-cell ISE sensors to provide accurate and repeatable measurements. HANNA's combination electrodes incorporate the measuring electrode with the reference making them ideal for field measurements.



Reference Electrodes are used to provide a stable voltage and electrolytic contact to permit a voltage gradient to be measured across a measurement membrane such as an ISE. HANNA has designed an easy to use, unbreakable plastic, double junction, quick fill, sleeve style reference electrode with a cone style junction to work with the ion selective electrode family of sensors. The design forms the liquid junction with the test solution at the tip of the junction cone and not further up the cone surface. The design produces a highly stable reference electrode with reasonable

low flow rates. The model HI 5315 is a silver/silver chloride electrode half-cell with a permanent gel filled internal cell. The outer fill solution is easily replaceable and serves as a buffer zone between the internal chloride ion containing gel and the sample solution. HANNA offers a complete line of silver-free fill solutions to optimize your ion measurement. A fast responding liquid junction, excellent reproducibility, and ease of use will mark this reference as your "best" in the lab.



Combination Electrodes include a sensor and reference electrode in a single electrode body. Our combination ion selective electrodes provide the same selectivity and response as our ISE half-cells, but include our superior double junction reference into the same electrode body. Combination solid state electrodes have a built in solid state sensor and quick refillable reference electrode. Our liquid membrane and fluoride combination electrodes have replaceable module construction and the HANNA double junction reference stability.

Three Methods of Analysis

Potentiometric ion analyses with ISEs are performed by use of one of three methods, each entailing its own advantages: Direct Potentiometry, Incremental Methods, and Potentiometric Titration. HANNA offers a solution for each of these methods, for more details please refer to our Solutions Section.

HI 4101 • HI 4002 • HI 4102 • HI 4003 • HI 4103

Ammonia • Bromide • Cadmium

Ion Selective Electrodes



PARAMETER	AMMONIA	BROMIDE		CADMIUM	
Code	HI 4101	HI 4002	HI 4102	HI 4003	HI 4103
Type	Gas-Sensing; Combination	Solid-state; Half-cell	Solid-state; Combination	Solid-state; Half-cell	Solid-state; Combination
Measurement Range	1M to 1X 10 ⁻⁴ M 17000 to 0.02 ppm	1M to 1X 10 ⁻⁴ M 79910 to 0.08 ppm	1M to 1X 10 ⁻⁴ M 79910 to 0.08 ppm	1M to 1X 10 ⁻⁷ M 11200 to 0.01 ppm	1M to 1X 10 ⁻⁷ M 11200 to 0.01 ppm
Optimum pH Range	>11	2 to 12.5	2 to 12.5	2 to 12.5	2 to 12.5
Temperature Range	0 to 40°C	0 to 80°C	0 to 80°C	0 to 80°C	0 to 80°C
Approximate Slope	-56	-56	-56	+28	+28
Body O.D.	12 mm	12 mm	12 mm	12 mm	12 mm
Insertion Length	120 mm	120 mm	120 mm	120 mm	120 mm
Body Material	Delrin	Epoxy	PEI	Epoxy	PEI
Cable	1m coaxial	1m coaxial	1m coaxial	1m coaxial	1m coaxial
Connector	BNC	BNC	BNC	BNC	BNC
Possible Applications	Determination of ammonium, ammonia in wine, beer, water, waste water and soil	Determination of free bromide ions in emulsified food products, beverages, plants, soils and as an indicator for titration		Used as an indicator for titrations using chelates	

HI 4004 • HI 4104 • HI 4105 • HI 4007 • HI 4107
Calcium • Carbon Dioxide • Chloride

Ion Selective Electrodes

ISE/pH
 Ion Selective Electrodes



PARAMETER	CALCIUM		CARBON DIOXIDE	CHLORIDE	
Code	HI 4004	HI 4104	HI 4105	HI 4007	HI 4107
Type	Polymer Membrane; Half-cell	Polymer Membrane; Combination	Gas Sensing; Combination	Solid-state; Half-cell	Solid-state; Combination
Measurement Range	1M to 3X 10 ⁻⁶ M 40080 to 0.12 ppm	1M to 3X 10 ⁻⁶ M 40080 to 0.12 ppm	1X 10 ⁻² M to 1X 10 ⁻⁴ M 440 to 4.4 ppm	1M to 5X 10 ⁻⁶ M 35000 to 1.8 ppm	1M to 5X 10 ⁻⁶ M 35000 to 1.8 ppm
Optimum pH Range	4 to 10	4 to 10	4.2 to 5.2	2 to 11	2 to 11
Temperature Range	0 to 40°C	0 to 40°C	0 to 40°C	0 to 80°C	0 to 80°C
Approximate Slope	+28	+28	+54	-57	-57
Body O.D.	12 mm	12 mm	12 mm	12 mm	12 mm
Insertion Length	120 mm	120 mm	120 mm	120 mm	120 mm
Body Material	PVC	PEI/PVC	Delrin	Epoxy	PEI
Cable	1m coaxial	1m coaxial	1m coaxial	1m coaxial	1m coaxial
Connector	BNC	BNC	BNC	BNC	BNC
Possible Applications	Determination of free calcium in beverages, water, and seawater		Determination of carbonates as CO ₂ in water, soft drinks and wine samples	Determination of free chloride ions in emulsified food products, beverages, plants, soils and as an indicator for titration	

HI 4008 • HI 4108 • HI 4009 • HI 4109 • HI 4010 • HI 4110

Cupric • Cyanide • Fluoride

Ion Selective Electrodes



PARAMETER	CUPRIC		CYANIDE		FLUORIDE	
Code	HI 4008	HI 4108	HI 4009	HI 4109	HI 4010	HI 4110
Type	Solid-state; Half-cell	Solid-state; Combination	Solid-state; Half-cell	Solid-state; Combination	Solid-state; Half-cell	Solid-state; Combination
Measurement Range	0.1M to 1X 10 ⁻⁴ M 6354 to 0.06 ppm	0.1M to 1X 10 ⁻⁴ M 6354 to 0.06 ppm	10 ⁻² M to 1X 10 ⁻⁴ M 260 to 0.02 ppm	10 ⁻² M to 1X 10 ⁻⁴ M 260 to 0.02 ppm	1M to 1X 10 ⁻⁴ M Sat. to 0.02 ppm	1M to 1X 10 ⁻⁴ M Sat. to 0.02 ppm
Optimum pH Range	2 to 12.5	2 to 12.5	>11	>11	5 to 8	5 to 8
Temperature Range	0 to 80°C	0 to 80°C	0 to 80°C	0 to 80°C	0 to 80°C	0 to 80°C
Approximate Slope	26	26	-57	-57	-56	-56
Body O.D.	12 mm	12 mm	12 mm	12 mm	12 mm	12 mm
Insertion Length	120 mm	120 mm	120 mm	120 mm	120 mm	120 mm
Body Material	Epoxy	PEI	Epoxy	PEI	Epoxy	PEI/Epoxy
Cable	1m coaxial	1m coaxial	1m coaxial	1m coaxial	1m coaxial	1m coaxial
Connector	BNC	BNC	BNC	BNC	BNC	BNC
Possible Applications	Used as an indicator for titrations using chelates		Determination of free cyanide ions in plating baths, waste water and in plant and soil samples		Determination of free fluoride in potable water, soft drinks, wine, plants, emulsified food products, plating and pickling acids	

Iodide • Lead/Sulfate • Nitrate

Ion Selective Electrodes



PARAMETER	IODIDE		LEAD/SULFATE		NITRATE	
Code	HI 4011	HI 4111	HI 4012	HI 4112	HI 4013	HI 4113
Type	Solid-state; Half-cell	Solid-state; Combination	Solid-state; Half-cell	Solid-state; Combination	Polymer Membrane; Half-cell	Polymer Membrane; Combination
Measurement Range	1M to 1X 10 ⁻⁷ M 127000 to 0.01 ppm	1M to 1X 10 ⁻⁷ M 127000 to 0.01 ppm	0.1M to 1X 10 ⁻⁶ M 20700 to 0.21 ppm	0.1M to 1X 10 ⁻⁶ M 20700 to 0.21 ppm	1.0M to 1X 10 ⁻³ M 6200 to .62 ppm	1.0M to 1X 10 ⁻³ M 6200 to .62 ppm
Optimum pH Range	2 to 13	2 to 13	4 to 7	4 to 7	3.0 to 8	3.0 to 8
Temperature Range	0 to 80°C	0 to 80°C	0 to 80°C	0 to 80°C	0 to 40°C	0 to 40°C
Approximate Slope	-56	-56	+25	+25	-56	-56
Body O.D.	12 mm	12 mm	12 mm	12 mm	12 mm	12 mm
Insertion Length	120 mm	120 mm	120 mm	120 mm	120 mm	120 mm
Body Material	Epoxy	PEI	Epoxy	PEI	PVC	PEI/PVC
Cable	1m coaxial	1m coaxial	1m coaxial	1m coaxial	1m coaxial	1m coaxial
Connector	BNC	BNC	BNC	BNC	BNC	BNC
Possible Applications	Determination of free iodide ions in emulsified food samples (iodized table salt), plants and for titration		Determination of lead ions in plating baths and as an indicator for titrations		Determination of free nitrate in natural waters (fresh and sea), and in emulsified food and plant samples	

4114 • HI 4015 • HI 4115 • HI 5315

Potassium • Silver/Sulfide • Reference

Ion Selective Electrodes



PARAMETER	POTASSIUM		SILVER/SULFIDE		REFERENCE
	HI 4014	HI 4114	HI 4015	HI 4115	HI 5315
Type	Polymer Membrane; Half-cell	Polymer Membrane; Combination	Solid-state; Half-cell	Solid-state; Combination	N/A
Measurement Range	1M to 1X 10 ⁻⁶ M 39100 to .039 ppm	1M to 1X 10 ⁻⁶ M 39100 to .039 ppm	Ag ⁺ 1.0M to 1X 10 ⁻⁶ M 107900 to 0.11 ppm S ²⁻ 1.0M to 1X 10 ⁻⁷ M 32100 to 0.003 ppm	Ag ⁺ 1.0M to 1X 10 ⁻⁶ M 107900 to 0.11 ppm S ²⁻ 1.0M to 1X 10 ⁻⁷ M 32100 to 0.003 ppm	N/A
Optimum pH Range	1.5 to 12.0	1.5 to 12.0	Ag ⁺ 2 to 8 S ²⁻ 12 to 14	Ag ⁺ 2 to 8 S ²⁻ 12 to 14	N/A
Temperature Range	0 to 40°C	0 to 40°C	0 to 80°C	0 to 80°C	0 to 80°C
Approximate Slope	+56	+56	+56 Ag ⁺ / -28 S ²⁻	+56 Ag ⁺ / -28 S ²⁻	N/A
Body O.D.	12 mm	12 mm	12 mm	12 mm	12 mm
Insertion Length	120 mm	120 mm	120 mm	120 mm	120 mm
Body Material	PVC	PEI/PVC	Epoxy	PEI	PEI
Cable	1m coaxial	1m coaxial	1m coaxial	1m coaxial	1m coaxial
Connector	BNC	BNC	BNC	BNC	Banana
Possible Applications	Determination of potassium ions in wine, waters, soils and biological samples.		As an indicator for titrations using silver nitrate. For the determination of sulfide ions in waters, paper liquors, natural waters and soils.		To complete the electrical circuit and to provide a stable reference voltage for ISE half-cells

Ion Selective

Sensors and Accessories Reference Chart

Sensors and Accessories Reference Chart

Electrode	Type	Half-cell	Combination	ISA	Filling Solution	Standard 1	Standard 2	Standard 3	Other
Ammonia	Gas	—	HI 4101	HI 4001-00	HI 4001-40	HI 4001-01 0.1 M	HI 4001-02 100 ppm	HI 4001-03 1000 ppm	HI 4000-52 replacement cap HI 4001-51 membrane kit HI 4000-51 replacement pH internal and cap for Ammonia HI 4001-45 conditioning solution HI 4000-47 4 and 7 pH with salt
Bromide	Solid	HI 4002	HI 4102	HI 4000-00	HI 7072	HI 4002-01 0.1 M			HI 4000-70 polishing strip
Cadmium	Solid	HI 4003	HI 4103	HI 4000-00	HI 7072	HI 4003-01 0.1 M			HI 4000-70 polishing strip
Calcium	Polymer membrane	HI 4004	HI 4104	HI 4004-00	HI 7082	HI 4004-01 0.1 M			HI 4004-51 module HI 4104-51 module for combination HI 4004-45 Conditioning Solution
Carbon Dioxide	Gas	—	HI 4105	HI 4005-00	HI 4005-40	HI 4005-01 0.1 M		HI 4005-03 1000 ppm	HI 4000-54 replacement pH internal & cap for CO ₂ HI 4005-53 CO ₂ membrane kit (3 pack) HI 4000-47 4 and 7 pH with salt HI 4005-45 Conditioning Solution
Chloride	Solid	HI 4007	HI 4107	HI 4000-00	HI 7072	HI 4007-01 0.1 M	HI 4007-02 100 ppm	HI 4007-03 1000 ppm	HI 4000-70 polishing strip
Cupric	Solid	HI 4008	HI 4108	HI 4000-00	HI 7072	HI 4008-01 0.1 M			HI 4000-70 polishing strip
Cyanide	Solid	HI 4009	HI 4109	HI 4001-00	HI 7072				HI 4000-70 polishing strip
Fluoride	Solid	HI 4010	HI 4110	HI 4010-00 HI 4010-05 HI 4010-06 HI 4010-30	HI 7075	HI 4010-01 0.1M	HI 4010-02 100 ppm	HI 4010-03 1000 pm	HI 4010-11 1 ppm with TISAB II HI 4010-12 2 ppm with TISAB II HI 4010-10 10 ppm with TISAB II HI 4110-51 module for combination HI 4010-30 Fluoride measurement kit
Iodide	Solid	HI 4011	HI 4111	HI 4000-00	HI 7072	HI 4011-01 0.1 M			HI 4000-70 polishing strip
Lead/Sulfate	Solid	HI 4012	HI 4112	HI 4012-00	HI 7072	HI 4012-01 Lead HI 4012-21 Sulfate 0.1 M			HI 4000-70 polishing strip
Nitrate	Polymer membrane	HI 4013	HI 4113	HI 4013-00	HI 7078	HI 4013-01 0.1 M	HI 4013-02 100 ppm	HI 4013-03 1000 ppm	HI 4013-53 module (3 pack) HI 4113-53 module for combination (3 pack) HI 4013-06 Interferent suppressent ISA
Potassium	Polymer membrane	HI 4014	HI 4114	HI 4014-00	HI 7076	HI 4014-01 0.1 M			HI 4014-51 module HI 4114-51 module for combination
Silver/Sulfide	Solid	HI 4015	HI 4115	HI 4000-00 (Ag ⁺) HI 4015-00 (S ²⁻)	HI 7072	HI 4015-01 0.1 M Silver			HI 4000-70 polishing strip
Reference	—	HI 5315			HI 7072 HI 7075 HI 7076 HI 7082 HI 7078				

ISE Solutions

Solutions Designed for our ISE Electrodes



HANNA ISE Standards

Our wide selection of HANNA ISE Standards are made and bottled in our own state-of-the-art solutions facility. ISE Standards are required for direct and incremental measurement techniques and are available with Certificate of Analysis.

Code	Description	Size
HI 4001-01	0.1 M ammonia std.	500 mL
HI 4001-02	100 ppm ammonia std. (as N)	500 mL
HI 4001-03	1000 ppm ammonia std. (as N)	500 mL
HI 4002-01	0.1 M bromide std.	500 mL
HI 4003-01	0.1 M cadmium std.	500 mL
HI 4004-01	0.1 M calcium std.	500 mL
HI 4005-01	0.1 M carbon dioxide std.	500 mL
HI 4005-03	1000 ppm carbon dioxide std. (as CaCO ₃)	500 mL
HI 4007-01	0.1 M chloride std.	500 mL
HI 4007-02	100 ppm chloride std.	500 mL
HI 4007-03	1000 ppm chloride std.	500 mL
HI 4008-01	0.1 M cupric std.	500 mL
HI 4010-01	0.1 M fluoride std.	500 mL
HI 4010-02	100 ppm fluoride std.	500 mL
HI 4010-03	1000 ppm fluoride std.	500 mL
HI 4010-10	10 ppm fluoride std. premixed with TISAB II	500 mL
HI 4010-11	1 ppm fluoride std. premixed with TISAB II	500 mL
HI 4010-12	2 ppm fluoride std. premixed with TISAB II	500 mL
HI 4010-30	(4) 1, (4) 10 ppm fluoride std. with (4) TISAB II	500 mL
HI 4011-01	0.1 M iodide std.	500 mL
HI 4012-01	0.1 M lead std.	500 mL
HI 4012-21	0.1 M sulfate std.	500 mL
HI 4013-01	0.1 M nitrate std.	500 mL
HI 4013-02	100 ppm nitrate std.	500 mL
HI 4013-03	1000 ppm nitrate std.	500 mL
HI 4014-01	0.1 M potassium std.	500 mL
HI 4015-01	0.1 M silver std.	500 mL

HANNA Gas Sensor Fill Solutions

Code	Description	Size
HI 4001-40	Ammonia filling solution	(4) 30 mL bottles
HI 4005-40	Carbon dioxide filling solution	(4) 30 mL bottles

Specific "Solutions" for ISE Sensors

Code	Description	Size
HI 4000-47	pH 4 and pH 7 buffers with chloride background. Used to check glass internal of gas sensors.	10 packages ea. and 2 beakers
HI 4001-45	Conditioning solution for HI 4101	500 mL
HI 4004-45	Conditioning Solution for calcium electrodes	500 mL
HI 4005-45	Conditioning Solution for HI 4105	500 mL



ISE Solutions

Solutions Designed for our ISE Electrodes



Ionic Strength Adjusters (ISA)

HANNA Ionic Strength Adjusters (ISA) are formulated to provide a constant ionic strength in sample and standards alike, thus permitting concentration rather than activity measurements to be made. In some cases ISA's adjust pH and eliminate matrix effects.

Code	Description	Size
HI 4000-00	ISA for halide electrodes	500 mL
HI 4001-00	Alkaline ISA for ammonia/cyanide	500 mL
HI 4004-00	Calcium ISA	500 mL
HI 4005-00	Carbon dioxide ISA	500mL
HI 4010-00	TISAB II (for fluoride)	500 mL
HI 4010-05	TISAB II (for fluoride)	1 gallon
HI 4010-06	TISAB III concentrate (for fluoride)	500 mL
HI 4012-00	Lead or sulfate ISA	500 mL
HI 4013-00	Nitrate ISA	500 mL
HI 4013-06	Nitrate interferent suppressant ISA	500 mL
HI 4014-00	Potassium ISA	500 mL
HI 4015-00	SAOB (sulfide antioxidant buffer)	500 mL, 1pkg (2 components)

HANNA Accessories

HANNA replacement parts and accessories keep your measurements fast and accurate.

Code	Description
HI 4000-50	Liquid membrane sensor handle
HI 4000-51	Gas sensor replacement pH for Ammonia Sensor
HI 4000-52	Gas sensor membrane cap for Ammonia
HI 4000-54	Gas sensor replacement pH for Carbon Dioxide Sensor
HI 4000-70	Halide polishing strip
HI 4001-51	Ammonia membrane kit (20 loose)
HI 4004-51	Calcium module for half-cell
HI 4104-51	Calcium module for combination
HI 4005-53	Carbon dioxide membrane kit (3 caps)
HI 4110-51	Fluoride module for combination electrode
HI 4013-53	Nitrate module 3 pack for half-cell
HI 4113-53	Nitrate module 3 pack for combination
HI 4014-51	Potassium module for half-cell
HI 4114-51	Potassium module for combination
HI 740155P	Capillary pipettes (20 pcs)
HI 740159	Plastic tweezers

HANNA Silver-free Reference Fill Solutions

Recommended for our Combination ISE Electrodes and the HANNA HI 5315 reference electrode. Reference electrodes should be topped off daily with the correct filling solution for optimum measurement performance. These solutions are silver free to eliminate silver precipitates found with standard electrolytes.

Code	Description	Size
HI 7072	Electrolyte solution, 1 M KNO ₃	(4) 30 mL bottles
HI 7075	Electrolyte solution with KNO ₃ and KCl	(4) 30 mL bottles
HI 7076	Electrolyte solution, 1 M NaCl	(4) 30 mL bottles
HI 7078	Electrolyte solution, (NH ₄) ₂ SO ₄	(4) 30 mL bottles
HI 7082	Electrolyte solution, 3.5 M KCl	(4) 30 mL bottles

pH and ORP Solutions

A Solution for Every Need

Calibration and Cleaning Solutions for Electrodes and Probes

The fundamental use of calibration and cleaning solutions is to correctly maintain electrode operation to produce accurate and reproducible readings. Often readings are not correct because the sensors have not been properly handled. Using HANNA's wide range of solutions will help guarantee correct cleaning and calibration of electrodes and probes for maximum performance.

Our application engineered solutions have been produced with reference instruments calibrated with the highest precision NIST standards. Our range of buffer and cleaning solutions have been extended with 3 new lines: the *HI 50xx series* of technical buffer solutions which allow for calibration of pH meters from 1.00 to 13.00 pH; *HI 60xx series* of solutions with millesimal resolutions available for pH and conductivity measurements, and *application specific cleaning solutions* available in bottles of 250 and 500 mL as well as in small sachets of 20 mL each.

Ready-to-Use Solutions

Buffer solutions that can be prepared in small batches from capsules, tablets or powders, are called "fresh" because they are prepared at the time of use. They are considered to be, but are not, very precise. The quality of buffer solutions depends on many factors that intervene during production: the quantity and quality of the chemicals and also distilled water that has been used in preparing the batches as well as the temperature and the instruments used to prepare them.

HANNA buffer solutions are prepared using chemicals that have been checked very carefully, within an aseptic environment and with the highest precision reference instruments.

The main standard buffer solutions produced by HANNA are available in bottles or in sealed sachets, complete with certificate of analysis.

HANNA solutions are more convenient than the so called "fresh" solutions. The following pages show all the series of calibration solutions in the various types of packages that will satisfy every application need and will always guarantee precise readings.

A Complete Range

The entire range of HANNA's solutions includes:

- *pH buffer solutions*
- *Standard solutions for conductivity, TDS, turbidity, salinity and ISE calibration*
- *ORP test and pretreatment solutions*
- *Reference fill solutions for refillable electrodes*
- *General and specific cleaning solutions for electrodes*
- *Solutions for electrode maintenance*
- *Solutions for sample preparation*

The solutions are available in many sizes to satisfy all different applications, from 20 mL sachets all the way to 3.78 L (1 Gallon) for the large quantities used in analytical laboratories.

For safety and traceability, all HANNA solutions are provided with a label showing the batch number and expiration date.



Ready-to-Use Single-Dose Sachets



Custom-made Solutions

Get the best out of your instruments using single-dose HANNA calibration and maintenance solutions. A wide range of solutions for pH, conductivity, TDS and cleaning is available in the form of practical 20 mL sachets.

Each sealed, light-tight sachet holds just the right amount of calibration solution ready for use.

Every time your instrument is calibrated using these HANNA sachets, it is like using a newly-opened bottle of solution.

Practical, Safe and Ready-to-Use

Single-dose sachets are ready for use and are available in different packages, with 10, 25 and 500 pieces. Each sachet is well sealed to ensure the longest life and maximum freshness for the solution.

Single-Dose Certified Solutions in Sachets

Solutions in sachets are also available with a certificate of analysis. Just like in our bottled solutions, the certificate shows the date of production, batch number and expiration date.

Combination Kits

To be more practical, HANNA solutions are also available in combined kits. These kits are useful for multiparameter instruments or for two-point calibration.

Custom Solutions



New Series of Solutions

To meet the requirements of various applications, the following categories of solutions are also available:

HI 50xx series, technical solutions: they allow for calibration at all units of pH from pH 1.00 to pH 13.00.

HI 60xx series, millesimal solutions: they allow for the correct calibration of pH meters with millesimal readings.

HI 706xx series, cleaning solutions: an indispensable tool when electrodes are used continuously. Produced with the purpose of ensuring correct readings in widely varied areas of application, they guarantee precise measurement and long electrode life.



pH and ORP Solutions

A Solution for Every Need

Certified Solutions

For those operators who request it, we provide standard solutions complete with certificate of analysis, prepared against NIST standards to avoid any possible error in determining the actual pH value.

The use of these certified HANNA solutions adds a further factor of accuracy to your most critical measurements. The certificates show the date of production, batch number, accuracy rating and the expiration date.

All solutions belonging to the series HI 50xx and HI 60xx are provided with a certificate of analysis. The certified solutions belonging to the HI 70xx series are identified by the letter "C" at the end of the part number.



Table of Reference Temperatures

All calibration solutions are provided with a label presenting a reference table of the relationship between pH or conductivity values and the temperature. This will save time and, most important, will prevent calibration errors especially during field measurements.

Bottles that Meet FDA Standards

In order for you to be certain of the accuracy of your instruments over time, ask for HANNA solutions in FDA type bottles (US Food & Drug Administration). These non-transparent bottles block light from reacting with light sensitive solutions thus promoting solution stability under adverse conditions.

Material Safety Data Sheet

Material Safety Data Sheets (MSDS) for each of the solutions included in the HANNA catalog can be downloaded from our website at: www.hannainst.com.



HI 5000 Series

pH Technical Calibration Solutions*A Complete Scale of Buffer Solutions***Precise Measurements**

To obtain precise and valid pH measurements, the pH meter and pH electrode must be calibrated at a minimum of 2 different points, close to the value of the sample to be tested.

HANNA offers a complete range of pH buffer solutions, that will satisfy all your calibration needs and which have been extended with two additional lines: the HI 50xx series of technical buffer solutions (shown on these pages,) and the solutions with millesimal resolution, HI 60xx.

**Technical Solutions
(± 0.01 pH) for
Each Point of the
pH Scale.**

This complete scale of buffer solutions offers a higher degree of accuracy for pH measurements in specific areas of application, such as in monitoring the pH of must and wine. This line includes 13 solutions starting from a value of pH 1.00 up to pH 13.00 with an accuracy of ± 0.01 pH, thus covering every point of the pH scale.

These solutions are dedicated to those applications that require extremely accurate pH monitoring, and are also available with certificate of analysis prepared by comparison against NIST standards.

Also available are solution bottles, that are colored according to a given standard calibration value: HI 5004-R (Red), HI 5007-G (Green) and HI 5010-V (Violet).

**BOTTLES**

pH Value @25°C	Code	Package
1.00	HI 5001	(1) 500 mL
1.68	HI 5016	(1) 500 mL
2.00	HI 5002	(1) 500 mL
2.00	HI 5002-01	(1) 1 L
2.00	HI 5002-36	(36) 500 mL
3.00	HI 5003	(1) 1 L
3.00	HI 5003-36	(36)500 mL
3.79	HI 5037	(1) 500 mL
4.01	HI 5004	(1) 500 mL
4.01	HI 5004-01	(1) 1 L
4.01	HI 5004-12	(12) 500 mL
4.01	HI 5004-36	(36) 500 mL
4.01	HI 5004-R	(1) 500 mL
4.01	HI 5004-R08	(1) 1 G (3.78 L)
4.01	HI 5004-R36	(36) 500 mL
4.63	HI 5046	(1) 500 mL
4.63	HI 5046-01	(1) 1 L
5.00	HI 5005	(1) 500 mL
5.00	HI 5005-01	(1) 1 L
6.00	HI 5006	(1) 500 mL
6.00	HI 5006-01	(1) 1 L
6.00	HI 5006-36	(36) 500 mL
6.86	HI 5068	(1) 500 mL
7.01	HI 5007	(1) 500 mL
7.01	HI 5007-01	(1) 1 L
7.01	HI 5007-12	(12) 500 mL
7.01	HI 5007-36	(36) 500 mL
7.01	HI 5007-G	(1) 500 mL
7.01	HI 5007-G08	(1) 1 G (3.78 L)
7.01	HI 5007-G36	(36) 500 mL
7.41	HI 5074	(1) 500 mL
7.41	HI 5074-01	(1) 1 L
8.00	HI 5008	(1) 500 mL
8.00	HI 5008-01	(1) 1 L
8.00	HI 5008-36	(36) 500 mL
9.00	HI 5009	(1) 500 mL
9.00	HI 5009-01	(1) 1 L
9.00	HI 5009-36	(36) 500 mL
9.18	HI 5091	(1) 500 mL
10.01	HI 5010	(1) 500 mL
10.01	HI 5010-01	(1) 1 L
10.01	HI 5010-12	(12) 500 mL
10.01	HI 5010-36	(36) 500 mL
10.01	HI 5010-V	(1) 500 mL
10.01	HI 5010-V08	(1) 1 G (3.78 L)
10.01	HI 5010-V36	(36) 500 mL
11.00	HI 5011	(1) 500 mL
12.00	HI 5012	(1) 500 mL
12.45	HI 5124	(1) 500 mL
13.00	HI 5013	(1) 500 mL

HI 5000 Series pH Technical Calibration Solutions

A Complete Scale of Buffer Solutions

SACHETS

pH Value @25°C	Code	Package
1.00	HI 50001-01	(10) 20 mL
1.00	HI 50001-02	(25) 20 mL
1.68	HI 50016-01	(10) 20 mL
1.68	HI 50016-02	(25) 20 mL
2.00	HI 50002-01	(10) 20 mL
2.00	HI 50002-02	(25) 20 mL
3.00	HI 50003-01	(10) 20 mL
3.00	HI 50003-02	(25) 20 mL
3.79	HI 50037-01	(10) 20 mL
3.79	HI 50037-02	(25) 20 mL
4.01	HI 50004-01	(10)20 mL
4.01	HI 50004-02	(25) 20 mL
4.63	HI 50046-01	(25) 20 mL
4.63	HI 50046-02	(25) 20 mL
5.00	HI 50005-01	(10) 20 mL
5.00	HI 50005-02	(25) 20 mL
6.00	HI 50006-01	(10) 20 mL
6.00	HI 50006-02	(25) 20 mL
6.86	HI 50068-01	(10) 20 mL
6.86	HI 50068-02	(25) 20 mL
7.01	HI 50007-01	(10) 20 mL
7.01	HI 50007-02	(25) 20 mL
7.41	HI 50074-01	(10) 20 mL
7.41	HI 50074-02	(25) 20 mL
8.00	HI 50008-01	(10) 20 mL
8.00	HI 50008-02	(25) 20 mL
9.00	HI 50009-01	(10) 20 mL
9.00	HI 50009-02	(25) 20 mL
9.18	HI 50091-01	(10) 20 mL
9.18	HI 50091-02	(25) 20 mL
10.01	HI 50010-01	(10) 20 mL
10.01	HI 50010-02	(25) 20 mL
11.00	HI 50011-01	(10) 20 mL
11.00	HI 50011-02	(25) 20 mL
12.00	HI 50012-01	(10) 20 mL
12.00	HI 50012-02	(25) 20 mL
12.45	HI 50124-01	(10) 20 mL
12.45	HI 50124-02	(25) 20 mL
13.00	HI 50013-01	(10) 20 mL
13.00	HI 50013-02	(25) 20 mL



Easy to Use Single Dose Sachets

For the highest level of reliability of field instrumentation, technical solutions are also provided in convenient single-dose sachets.

Calibration solution sachets are sold in boxes containing 10 or 25 pieces to satisfy requirements for daily use.



HANNA Combo Kits

Use our combination kits for easy ordering and reordering.

SOLUTION COMBINATION KITS - BOTTLE

Code	Solutions (pH Value @25°C)	Bottle
HI 54710	pH 4.01, pH 7.01, pH 10.01	(3) 500 mL
HI 54710-10	pH 4.01, pH 7.01, pH 10.01, HI 70300L	(4) 500 mL
HI 54710-11	pH 4.01, pH 7.01, pH 10.01, HI 70300L, HI 7061L	(5) 500 mL
HI 54710-12	pH 4.01, pH 7.01, pH 10.01, HI 70300L, HI 7061L, HI 7071L	(6) 500 mL
HI 54710-13	pH 4.01, pH 7.01, pH 10.01, HI 70300L, HI 7061L, HI 7072L	(6) 500 mL

HI 6000 Series

pH Millesimal Calibration Solutions

with ± 0.002 pH Accuracy

Millesimal Calibration Solutions

This line of buffers with millesimal accuracy (± 0.002 pH), HI 60xx, has been prepared to meet the increasing need for assured accuracy in pH measurements. Each bottle of the series HI 60xx is provided with a certificate of analysis, prepared by comparison with NIST standards.

MILLESIMAL BUFFER SOLUTIONS (± 0.002 pH) - BOTTLE

pH Value @25°C	Code	Package	pH Value @25°C	Code	Package
1.000	HI 6001	(1) 500 mL	7.010	HI 6007	(1) 500 mL
1.000	HI 6001-01	(1) 1 L	7.010	HI 6007-01	(1) 1 L
1.679	HI 6016	(1) 500 mL	7.413	HI 6074	(1) 500 mL
1.679	HI 6016-01	(1) 1 L	7.413	HI 6074-01	(1) 1 L
2.000	HI 6002	(1) 500 mL	8.000	HI 6008	(1) 500 mL
2.000	HI 6002-01	(1) 1 L	8.000	HI 6008-01	(1) 1 L
3.000	HI 6003	(1) 500 mL	9.000	HI 6009	(1) 500 mL
3.000	HI 6003-01	(1) 1 L	9.000	HI 6009-01	(1) 1 L
3.788	HI 6037	(1) 500 mL	9.177	HI 6091	(1) 500 mL
3.788	HI 6037-01	(1) 1 L	9.177	HI 6091-01	(1) 1 L
4.010	HI 6004	(1) 500 mL	10.010	HI 6010	(1) 500 mL
4.010	HI 6004-01	(1) 1 L	10.010	HI 6010-01	(1) 1 L
4.630	HI 6046	(1) 500 mL	11.000	HI 6011	(1) 500 mL
4.630	HI 6046-01	(1) 1 L	11.000	HI 6011-01	(1) 1 L
5.000	HI 6005	(1) 500 mL	12.000	HI 6012	(1) 500 mL
5.000	HI 6005-01	(1) 1 L	12.000	HI 6012-01	(1) 1 L
6.000	HI 6006	(1) 500 mL	12.450	HI 6124	(1) 500 mL
6.000	HI 6006-01	(1) 1 L	12.450	HI 6124-01	(1) 1 L
6.862	HI 6068	(1) 500 mL	13.000	HI 6013	(1) 500 mL
6.862	HI 6068-01	(1) 1 L	13.000	HI 6013-01	(1) 1 L



Light Tight
Multiple Use Bottles

MILLESIMAL BUFFER SOLUTIONS (± 0.002 pH) - SACHET

pH Value @25°C	Code	Package	pH Value @25°C	Code	Package
1.000	HI 60001-01	(10) 20 mL	7.010	HI 60007-01	(10) 20 mL
1.000	HI 60001-02	(25) 20 mL	7.010	HI 60007-02	(25) 20 mL
1.679	HI 60016-01	(10) 20 mL	7.413	HI 60074-01	(10) 20 mL
1.679	HI 60016-02	(25) 20 mL	7.413	HI 60074-02	(25) 20 mL
2.000	HI 60002-01	(10) 20 mL	8.000	HI 60008-01	(10) 20 mL
2.000	HI 60002-02	(25) 20 mL	8.000	HI 60008-02	(25) 20 mL
3.000	HI 60003-01	(10) 20 mL	9.000	HI 60009-01	(10) 20 mL
3.000	HI 60003-02	(25) 20 mL	9.000	HI 60009-02	(25) 20 mL
3.788	HI 60037-01	(10) 20 mL	9.177	HI 60091-01	(10) 20 mL
3.788	HI 60037-02	(25) 20 mL	9.177	HI 60091-02	(25) 20 mL
4.010	HI 60004-01	(10) 20 mL	10.010	HI 60010-01	(10) 20 mL
4.010	HI 60004-02	(25) 20 mL	10.010	HI 60010-02	(25) 20 mL
4.630	HI 60046-01	(10) 20 mL	11.000	HI 60011-01	(10) 20 mL
4.630	HI 60046-02	(25) 20 mL	11.000	HI 60011-02	(25) 20 mL
5.000	HI 60005-01	(10) 20 mL	12.000	HI 60012-01	(10) 20 mL
5.000	HI 60005-02	(25) 20 mL	12.000	HI 60012-02	(25) 20 mL
6.000	HI 60006-01	(10) 20 mL	12.450	HI 60124-01	(10) 20 mL
6.000	HI 60006-02	(25) 20 mL	12.450	HI 60124-02	(25) 20 mL
6.862	HI 60068-01	(10) 20 mL	13.000	HI 60013-01	(10) 20 mL
6.862	HI 60068-02	(25) 20 mL	13.000	HI 60013-02	(25) 20 mL

Easy Range Identification

The colors on the HI 60xx series packaging correspond to a given standard pH value. They make it easy and safe to identify the buffers to be used.



Certificates of Analysis are included.

Millesimal Calibration Solution Sachets

This series is also available in handy sachets to perform accurate calibrations on-site or in the field. Single dose sachet solutions are safe, easy to carry and always fresh.



Individually Packaged
Single-use Sachets

pH Standard Calibration Solutions

Quality Solutions for Laboratory Applications

Plating baths samples, food samples and waste samples are often acidic in nature. To increase accuracy of your measurement at lower pH, it is important to calibrate your electrode and meter at that pH also. HANNA pH 1.68 buffer is available to fulfill this requirement. pH 1.68 buffer solution allows you to calibrate your measurement system in the acid pH range and bracket your acidic samples by using a second value at 4 pH or near 7 pH.

Our millesimal series offers ± 0.002 certified accuracy and our HI 5016 technical grade solution offers ± 0.01 certified accuracy. Standard NIST traceable (no certification included) 1.68 pH buffer with ± 0.01 accuracy is available in two sizes.

Code	pH Value @25°C	Size	Package
HI 7001L	1.68	500 mL	1 bottle
HI 7001M	1.68	250 mL	1 bottle

1.68 | Buffer Solution



HANNA buffer solutions are prepared according to precise formulas and are standardized with a pH electrode and meter calibrated with NIST standards. This buffer value is widely used in water purification plants, in the food industry and where ever the pH is expected to be slightly acidic.

All pH 4 solutions show batch number, expiration date and the correlation table between pH and temperature.

Certified buffers are available with our technical and millesimal series. Standard NIST traceable (no certification included) 4.01 pH buffer with ± 0.01 accuracy is available in several convenient sizes.

4.01 | Buffer Solution

BOTTLES

Code	pH Value @25°C	Size	Package	FDA Bottle	Certificate of Analysis
HI 7004/1G	4.01	1 Gallon (3.78 L)	1 bottle		
HI 7004/1L	4.01	1 L	1 bottle		
HI 7004L	4.01	500 mL	1 bottle		
HI 7004L/C	4.01	500 mL	1 bottle		•
HI 7004M	4.01	250 mL	1 bottle		
HI 8004/1L	4.01	1 L	1 bottle	•	
HI 8004L	4.01	500 mL	1 bottle	•	
HI 8004L/C	4.01	500 mL	1 bottle	•	•

SACHETS

Code	pH Value @25°C	Size	Package	Certificate of Analysis
HI 70004C	4.01	20 mL	25 sachets	•
HI 70004P	4.01	20 mL	25 sachets	
HI 7004P/5	4.01	20 mL	500 sachets	
HI 77400C	4.01 & 7.01	20 mL	10 sachets (5 each)	•
HI 77400P	4.01 & 7.01	20 mL	10 sachets (5 each)	



HANNA pH 4 buffer is standardized against NIST references.

pH Standard Calibration Solutions

Quality Solutions for Laboratory Applications

6.86 | Buffer Solution



Traceability with Reference to NIST Standards

The buffer solution at pH 6.86 is standardized with a pH electrode and meter calibrated with NIST buffer solutions. The buffer is certified against to NIST standards.

Many of our latest portable and bench microprocessor instruments, may now be calibrated both with pH 6.86 or pH 7.01 buffers.

The HANNA range of pH 6.86 buffer solutions has been expanded and stability has been improved to match the stability of pH 7.

BOTTLES

Code	pH Value @25°C	Size	Package	FDA Bottle	Certificate of Analysis
HI 7006/1G	6.86	1 Gallon (3.78 L)	1 bottle		
HI 7006/1L	6.86	1 L	1 bottle		
HI 7006L	6.86	500 mL	1 bottle		
HI 7006L/C	6.86	500 mL	1 bottle		•
HI 7006M	6.86	250 mL	1 bottle		
HI 8006/1L	6.86	1 L	1 bottle	•	
HI 8006L	6.86	500 mL	1 bottle	•	
HI 8006L/C	6.86	500 mL	1 bottle	•	•

SACHETS

Code	pH Value	Size	Package	Certificate of Analysis
HI 70006C	6.86	20 mL	25 sachets	•
HI 70006P	6.86	20 mL	25 sachets	

7.01 | Buffer Solution

pH 7.01 is the most widely used among all buffer solutions. For this reason we have prepared it in a wider variety of sizes to meet application demand.

HANNA pH buffer solutions are standardized against NIST reference solutions.



FDA Approved Bottle

For maximum reliability choose our solutions in bottles that meet the FDA standards (US Food & Drug Administration) that protect the solutions from extended exposure to light.

BOTTLES

Code	pH Value @25°C	Size	Package	FDA Bottle	Certificate of Analysis
HI 7007/1G	7.01	1 Gallon (3.78 L)	1 bottle		
HI 7007/1L	7.01	1 L	1 bottle		
HI 7007L	7.01	500 mL	1 bottle		
HI 7007L/C	7.01	500 mL	1 bottle		•
HI 7007M	7.01	230 mL	1 bottle		
HI 8007/1L	7.01	1 L	1 bottle	•	
HI 8007L	7.01	500 mL	1 bottle	•	
HI 8007L/C	7.01	500 mL	1 bottle	•	•

SACHETS

Code	pH Value @25°C	Size	Package	Certificate of Analysis
HI 70007C	7.01	20 mL	25 sachets	•
HI 70007P	7.01	20 mL	25 sachets	
HI 7007P/5	7.01	20 mL	500 sachets	
HI 770710C	10.01 & 7.01	20 mL	10 sachets (5)	•
HI 770710P	10.01 & 7.01	20 mL	10 sachets (5)	
HI 77100C	1413 µS/cm & pH 7.01	20 mL	20 sachets (10)	•
HI 77100P	1413 µS/cm & pH 7.01	20 mL	20 sachets (10)	
HI 77200C*	1500 ppm (mg/L) & pH 7.01	20 mL	20 sachets (10)	•
HI 77200P*	1500 ppm (mg/L) & pH 7.01	20 mL	20 sachets (10)	
HI 77300C	1382 ppm (mg/L) & pH 7.01	20 mL	20 sachets (10)	•
HI 77300P	1382 ppm (mg/L) & pH 7.01	20 mL	20 sachets (10)	
HI 77400C	4.01 & 7.01	20 mL	10 sachets (5)	•
HI 77400P	4.01 & 7.01	20 mL	10 sachets (5)	
HI 77700C	7.01	20 mL	10 sachets (5)	•
HI 77700P	7.01	20 mL	10 sachets (5)	

*TDS Conversion Factor 4-4-2: 0.65 ppm = 1 µS/cm (approximately).

pH Standard Calibration Solutions

Quality Solutions for Laboratory Applications

To increase accuracy of your measurement in an alkaline environment, it is important to calibrate your electrode and meter in that pH range and to preferably bracket your sample values. HANNA offers both pH 9.18 buffer and 10.01 buffer to fulfill this requirement.

Our millesimal series offers ± 0.002 pH certified accuracy. Our HI 5091 technical grade solution offers ± 0.01 pH certified accuracy. Standard NIST traceable (no certification included) 9.18 pH buffer with ± 0.01 pH accuracy is available in several size bottles. The label indicates the batch code, expiration data and pH/temperature correlation table.

BOTTLES

Code	pH Value @25°C	Size	Package	FDA Bottle	Certificate of Analysis
HI 7009/1G	9.18	1 Gallon (3.78 L)	1 bottle		
HI 7009/1L	9.18	1 L	1 bottle		
HI 7009L	9.18	500 mL	1 bottle		
HI 7009L/C	9.18	500 mL	1 bottle		•
HI 7009M	9.18	250 mL	1 bottle		
HI 8009/L	9.18	500 mL	1 bottle	•	
HI 8009/1L	9.18	1 L	1 bottle	•	
HI 8009L/C	9.18	500 mL	1 bottle	•	•

SACHETS

Code	pH Value @25°C	Size	Package	Certificate of Analysis
HI 70009C	9.18	20 mL	25 sachets	•
HI 70009P	9.18	20 mL	25 sachets	

pH 10.01 solution is commonly used to calibrate equipment used for analyzing basic samples. pH 10 buffer solution is available in various forms: choose the one that best fits your needs.

BOTTLES

Code	pH Value @25°C	Size	Package	FDA Bottle	Certificate of Analysis
HI 7010/1G	10.01	1 Gallon (3.78 L)	1 bottle		
HI 7010/1L	10.01	1 L	1 bottle		
HI 7010L	10.01	500 mL	1 bottle		
HI 7010L/C	10.01	500 mL	1 bottle		•
HI 7010M	10.01	250 mL	1 bottle		
HI 8010/1L	10.01	1 L	1 bottle	•	
HI 8010L	10.01	500 mL	1 bottle	•	
HI 8010L/C	10.01	500 mL	1 bottle	•	•

SACHETS

Code	pH Value @25°C	Size	Package	Certificate of Analysis
HI 70010C	10.01	20 mL	25 sachets	•
HI 70010P	10.01	20 mL	25 sachets	
HI 70010P/5	10.01	20 mL	500 sachets	
HI 770710C	10.01 & 7.01	20 mL	10 sachets (5)	•
HI 770710P	10.01 & 7.01	20 mL	10 sachets (5)	

9.18 | Buffer Solution



Traceability with NIST Reference Standard

HANNA buffer solutions are prepared using very pure chemicals, in closely controlled laboratories, and with pH meters calibrated with NIST references.

10.01 | Buffer Solution



Traceability with NIST Standard Reference

HANNA pH 10 buffers are carefully prepared using the highest quality ingredients available and are standardized with NIST references.

ORP, Refill, Cleaning and Storage Solutions

Ensure the Maximum the Life of Your Electrodes

ORP Test and Pretreatment | Solutions

Code	Description	Package
HI 7020L	ORP Test Solution at 200/275 mV (@20°C)	500 mL bottle
HI 7020M	ORP Test Solution at 200/275 mV (@20°C)	250 mL bottle
HI 7021L	ORP Test Solution at 240 mV (@20°C)	500 mL bottle
HI 7021M	ORP Test Solution at 240 mV (@20°C)	250 mL bottle
HI 7022L	ORP Test Solution at 470 mV (@20°C)	500 mL bottle
HI 7022M	ORP Test Solution at 470 mV (@20°C)	250 mL bottle
HI 7091L	Reducing Pretreatment Solution	500 mL bottle
HI 7091M	Reducing Pretreatment Solution	250 mL bottle
HI 7092L	Oxidizing Pretreatment Solution	500 mL bottle
HI 7092M	Oxidizing Pretreatment Solution	250 mL bottle

Electrode Refilling | Solutions

Code	Description	Package
HI 7071	Electrolyte Solution, 3.5M KCl + AgCl	(4) 30 mL bottle
HI 7071L	Electrolyte Solution, 3.5M KCl + AgCl	500 mL bottle
HI 7072	Electrolyte Solution, 1M KNO ₃	(4) 30 mL bottle
HI 7072L	Electrolyte Solution, 1M KNO ₃	500 mL bottle
HI 7075	Electrolyte Solution, 1.7M KNO ₃ , 0.7M KCl	(4) 30 mL bottle
HI 7076	Electrolyte Solution, 1.0M NaCl	(4) 30 mL bottle
HI 7078	Electrolyte Solution, 1.7M KNO ₃ , 0.7M KCl	(4) 30 mL bottle
HI 7082	Electrolyte Solution, 0.5M (NH ₄) ₂ SO ₄	(4) 30 mL bottle
HI 8071	Electrolyte Solution, 3.5M KCl + AgCl	(4) 30 mL FDA bottle
HI 8072	Electrolyte Solution, 1M KNO ₃	(4) 30 mL FDA bottle
HI 8082	Electrolyte Solution, 3.5M KCl	(4) 30 mL FDA bottle
HI 8093	Electrolyte Solution, 1M KCl + AgCl	(4) 30 mL FDA bottle

Electrode Storage | Solutions

Code	Description	Package
HI 70300L	Electrode Storage Solution	500 mL bottle
HI 70300M	Electrode Storage Solution	250 mL bottle
HI 80300L	Electrode Storage Solution	500 mL FDA bottle
HI 80300M	Electrode Storage Solution	250 mL FDA bottle

Cleaning | Solutions for General Use

Code	Application	Package
HI 7000P	Rinsing	(25) 20 mL sachet
HI 7061L	General Purpose	500 mL bottle
HI 7061M	General Purpose	250 mL bottle
HI 7073L	Proteins	500 mL bottle
HI 7073M	Proteins	250 mL bottle
HI 7074L	Inorganic Substances	500 mL bottle
HI 7074M	Inorganic Substances	250 mL bottle
HI 7077L	Oil and Fats	500 mL bottle
HI 7077M	Oil and Fats	250 mL bottle
HI 8061L	General Purpose	500 mL FDA bottle
HI 8061M	General Purpose	250 mL FDA bottle
HI 8073L	Proteins	500 mL FDA bottle
HI 8073M	Proteins	250 mL FDA bottle
HI 8077L	Oil and Fats	500 mL FDA bottle
HI 8077M	Oil and Fats	250 mL FDA bottle

ORP Standard Solutions

ORP standard solutions allows users to test the precision of ORP electrodes. For example, by immersing the electrode in HI 7020 solution, readings should fall within the 200 to 275 mV range (@20°C/68°F).

If the reading is outside the indicated interval, clean and condition your ORP electrode in HANNA pretreatment solution.

Use HI 7092 for oxidizing or HI 7091 for reducing pretreatment.

Electrode Fill Solutions

The electrolyte level in refillable electrodes should be checked before performing any measurement. If the level is low, refill with the proper electrolyte solution to ensure the correct electrode performance.

This simple maintenance helps guarantee adequate head pressure to promote efficiency and precision of your refillable electrodes.

Some electrolyte solutions are also available in FDA compliant bottles.

Electrode Storage Solutions

To minimize junction clogging and ensure fast response time, always keep the glass bulb and the junction of your pH electrode moist. Store the electrode with a few drops of HI 70300 storage or pH 7 buffer solution in the protective cap.

General Cleaning

Clean the liquid junction of your electrodes once a day or at least once a week to prevent junction clogging and to maintain accuracy. Immerse the electrode in the proper cleaning solution for at least 15-20 minutes.

HANNA offers a wide range of cleaning solutions, for general purpose and specific applications to dissolve many deposits from the electrode, and thus ensure correct measurements.



Sample Preparation | Solutions

Code	Description	Package
HI 7051M	Soil Sample Preparation Solution	250 mL bottle
HI 7051L	Soil Sample Preparation Solution	500 mL bottle
HI 70960	Preparation Solution for Solid or Semi Solid Samples	30 mL bottle

Standard Solutions

for Turbidity, Salinity and Fluoride



Turbidity Standard Solutions

The HANNA turbidity calibration solutions are referenced to the AMCO AEPA-1 standards, at 0, 10, 20 and 500 FTU.

They are preferred to the formazine based standards, as they are non-toxic, stable, reusable and long-lasting.

Sodium Standard Solutions

The sodium and sodium chloride standard solutions allow you to perform an accurate calibration of the pocket sized, portable and bench salinity meters.

These solutions are available in 250 or 500 mL bottles, and also in opaque bottles that meet the FDA (Food & Drug Administration) specifications.

Fluoride Standard Solutions

These standard solutions allow you to calibrate all instruments that measure fluoride using ion-specific sensors.

The most common applications include drinking water, the analysis of water from springs close to volcanic rocks, or the cosmetics, pharmaceutical, glass and steel industries.

Fluoride Standard Solutions

Code	Description	Bottle
HI 7023/1L	TISAB Solution	1 L
HI 7023L	TISAB Solution	500 mL
HI 70701/1L	Standard Solution at 1 g/L F ⁻	1 L
HI 70701L	Standard Solution at 1 g/L F ⁻	500 mL
HI 70701M	Standard Solution at 1 g/L F ⁻	250 mL
HI 70702/1L	Standard Solution at 10 mg/L F ⁻	1 L
HI 70702L	Standard Solution at 10 mg/L F ⁻	500 mL
HI 70702M	Standard Solution at 10 mg/L F ⁻	250 mL
HI 70703/1L	Standard Solution at 100 mg/L F ⁻	1 L
HI 70703L	Standard Solution at 100 mg/L F ⁻	500 mL
HI 70703M	Standard Solution at 100 mg/L F ⁻	250 mL

Turbidity Standard Solutions

Code	Description	Package
HI 93102-0	AMCO-AEPA-1 Calibration Solution at 0 NTU	30 mL bottle
HI 93102-20	AMCO-AEPA-1 Calibration Solution at 20 NTU	30 mL bottle
HI 93124-0	Standard Solution at 0 EBC	30 mL bottle
HI 93124-1	Standard Solution at 2.5 EBC	30 mL bottle
HI 93124-2	Standard Solution at 125 EBC	30 mL bottle
HI 93703-0	AMCO-AEPA-1 Calibration Solution at 0 FTU	30 mL bottle
HI 93703-05	AMCO-AEPA-1 Calibration Solution at 500 FTU	30 mL bottle
HI 93703-10	AMCO-AEPA-1 Calibration Solution at 10 FTU	30 mL bottle

Sodium (Na⁺) Standard Solutions

Code	Description	Package
HI 7080L	Standard Solution at 2.3 g/L Na ⁺	500 mL bottle
HI 7080M	Standard Solution at 2.3 g/L Na ⁺	250 mL bottle
HI 7086L	Standard Solution at 23 g/L Na ⁺	500 mL bottle
HI 7086M	Standard Solution at 23 g/L Na ⁺	250 mL bottle
HI 7087L	Standard Solution at 0.23 g/L Na ⁺	500 mL bottle
HI 7087M	Standard Solution at 0.23 g/L Na ⁺	250 mL bottle
HI 8080L	Standard Solution at 2.3 g/L Na ⁺	500 mL FDA bottle
HI 8080M	Standard Solution at 2.3 g/L Na ⁺	250 mL FDA bottle
HI 8086L	Standard Solution at 23 g/L Na ⁺	500 mL FDA bottle
HI 8086M	Standard Solution at 23 g/L Na ⁺	250 mL FDA bottle
HI 8087L	Standard Solution at 0.23 g/L Na ⁺	500 mL FDA bottle
HI 8087M	Standard Solution at 0.23 g/L Na ⁺	250 mL FDA bottle

Sodium Chloride (NaCl) Standard Solutions

Code	Description	Package
HI 7037L	Calibration solution for % Readings (100% NaCl)	500 mL bottle
HI 7037M	Calibration solution for % Readings (100% NaCl)	250 mL bottle
HI 7081L	Standard Solution at 30 g/L NaCl	500 mL bottle
HI 7081M	Standard Solution at 30 g/L NaCl	250 mL bottle
HI 7083L	Standard Solution at 3.0 g/L NaCl	500 mL bottle
HI 7083M	Standard Solution at 3.0 g/L NaCl	250 mL bottle
HI 7084L	Standard Solution at 58.4 g/L NaCl	500 mL bottle
HI 7084M	Standard Solution at 58.4 g/L NaCl	250 mL bottle
HI 7085L	Standard Solution at 0.3 g/L NaCl	500 mL bottle
HI 7085M	Standard Solution at 0.3 g/L NaCl	250 mL bottle
HI 7088L	Standard Solution at 5.84 g/L NaCl	500 mL bottle
HI 7088M	Standard Solution at 5.84 g/L NaCl	250 mL bottle
HI 7089L	Standard Solution at 125 g/L NaCl	500 mL bottle
HI 7089M	Standard Solution at 125 g/L NaCl	250 mL bottle
HI 7090L	ISA Solution	500 mL bottle
HI 7090M	ISA Solution	250 mL bottle
HI 8084L	Standard Solution at 58.4 g/L NaCl	500 mL FDA bottle
HI 8084M	Standard Solution at 58.4 g/L NaCl	250 mL FDA bottle
HI 8088L	Standard Solution at 5.84 g/L NaCl	500 mL FDA bottle
HI 8088M	Standard Solution at 5.84 g/L NaCl	250 mL FDA bottle
HI 8089L	Standard Solution at 125 g/L NaCl	500 mL FDA bottle
HI 8089M	Standard Solution at 125 g/L NaCl	250 mL FDA bottle
HI 8095L	Standard Solution at 146 g/L NaCl	500 mL FDA bottle
HI 8095M	Standard Solution at 146 g/L NaCl	250 mL FDA bottle

New Specific Application Cleaning Solutions

Solutions Dedicated to Clean Specific Stains and Deposits



Focused Cleaning for A Top Performing Sensor

In many applications, electrodes become dirty from use with negative results on their efficiency. Since this dirt is not removed during normal use, special cleaning solutions are needed.

HANNA has prepared a complete line of cleaning and disinfection solutions that eliminate impurities and residues left on electrode surfaces when immersed in special samples such as wines, musts, oils, soil, industrial solutions, grease, algae, and dairy products.

The *Cleaning Solution Series* ensures the maximum efficiency and accuracy of your sensors when used for its designated application.

This line of products are available in 250 and 500 mL bottles as well as 20 mL sachets in packs of 25.

The easy to open and always fresh sachet package is a practical and ideal solution for field measurements.

Readings of Electrodes Cleaned with Different Procedures

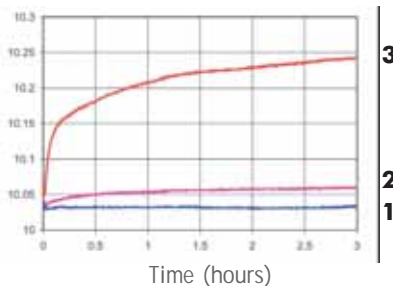

Electrode 1 has been properly cleaned before calibration. Electrodes 2 & 3 have not been properly cleaned.



BOTTLES

Code	Description	Bottle
HI 70620L	Cleaning and Disinfection Solution for Skin Residuals (Cosmetic Industry)	500 mL
HI 70620M	Cleaning and Disinfection Solution for Skin Residuals (Cosmetic Industry)	250 mL
HI 70621L	Cleaning Solution for Skin Grease and Sebum (Cosmetic Industry)	500 mL
HI 70621M	Cleaning Solution for Skin Grease and Sebum (Cosmetic Industry)	250 mL
HI 70630L	Acid Cleaning Solution for Meat Grease and Fats (Food Industry)	500 mL
HI 70630M	Acid Cleaning Solution for Meat Grease and Fats (Food Industry)	250 mL
HI 70631L	Alkaline Cleaning Solution for Meat Grease and Fats (Food Industry)	500 mL
HI 70631M	Alkaline Cleaning Solution for Meat Grease and Fats (Food Industry)	250 mL
HI 70632L	Cleaning and Disinfection Solution for Blood Products	500 mL
HI 70632M	Cleaning and Disinfection Solution for Blood Products	250 mL
HI 70635L	Cleaning Solution for Wine Deposits (Wine-Making)	500 mL
HI 70635M	Cleaning Solution for Wine Deposits (Wine-Making)	250 mL
HI 70636L	Cleaning Solution for Wine Stains (Wine-Making)	500 mL
HI 70636M	Cleaning Solution for Wine Stains (Wine-Making)	250 mL
HI 70640L	Cleaning Solution for Milk Deposits (Food Industry)	500 mL
HI 70640M	Cleaning Solution for Milk Deposits (Food Industry)	250 mL
HI 70641L	Cleaning and Disinfection Solution for Dairy Products (Food Industry)	500 mL
HI 70641M	Cleaning and Disinfection Solution for Dairy Products (Food Industry)	250 mL
HI 70642L	Cleaning Solution for Cheese Deposits (Food Industry)	500 mL
HI 70642M	Cleaning Solution for Cheese Deposits (Food Industry)	250 mL
HI 70663L	Cleaning Solution for Soil Deposits (Agriculture)	500 mL
HI 70663M	Cleaning Solution for Soil Deposits (Agriculture)	250 mL
HI 70664L	Cleaning Solution for Humus Deposits (Agriculture)	500 mL
HI 70664M	Cleaning Solution for Humus Deposits (Agriculture)	250 mL
HI 70670L	Cleaning Solution for Salt Deposits (Industrial Processes)	500 mL
HI 70670M	Cleaning Solution for Salt Deposits (Industrial Processes)	250 mL
HI 70671L	Cleaning and Disinfection Solution for Algae, Fungi and Bacteria (Industrial Processes)	500 mL
HI 70671M	Cleaning and Disinfection Solution for Algae, Fungi and Bacteria (Industrial Processes)	250 mL
HI 70680L	Cleaning Solution for Cellulose Deposits	500 mL
HI 70680M	Cleaning Solution for Cellulose Deposits	250 mL
HI 70681L	Cleaning Solution for Ink Stains	500 mL
HI 70681M	Cleaning Solution for Ink Stains	250 mL

SACHETS

Code	Description	Sachet
HI 700620P	Cleaning and Disinfection Solution for Skin Residuals (Cosmetic Industry)	(25) 20 mL
HI 700621P	Cleaning Solution for Skin Grease and Sebum (Cosmetic Industry)	(25) 20 mL
HI 700630P	Acid Cleaning Solution for Meat Grease and Fats (Food Industry)	(25) 20 mL
HI 700635P	Cleaning Solution for Wine Deposits (Wine-Making)	(25) 20 mL
HI 700636P	Cleaning Solution for Wine Stains (Wine-Making)	(25) 20 mL
HI 700640P	Cleaning Solution for Milk Deposits (Food Industry)	(25) 20 mL
HI 700641P	Cleaning and Disinfection Solution for Dairy Products (Food Industry)	(25) 20 mL
HI 700642P	Cleaning Solution for Cheese Deposits (Food Industry)	(25) 20 mL
HI 700661P	General Purpose Cleaning Solution for Agriculture	(25) 20 mL
HI 700663P	Cleaning Solution for Soil Deposits (Agriculture)	(25) 20 mL
HI 700664P	Cleaning Solution for Humus Deposits (Agriculture)	(25) 20 mL
HI 700670P	Cleaning Solution for Salt Deposits (Industrial Processes)	(25) 20 mL
HI 700671P	Cleaning and Disinfection Solution for Algae, Fungi and Bacteria (Industrial Processes)	(25) 20 mL
HI 700680P	Cleaning Solution for Ink Stains	(25) 20 mL



HI 4321

Conductivity/TDS Meter

Research Grade Meter with Color Display and USP

Advanced Bench Meter with an Extended Range

HI 4321 is a research-grade laboratory EC/Resistivity/TDS/Salinity bench meter with a backlit 240 x 320 dot-matrix color screen and millesimal measuring resolution.

The HI 4321 features auto-recognition of probe type (2 or 4 ring and nominal cell constant) and has an extended range from 0.001 $\mu\text{S}/\text{cm}$ to 1 S/cm. Users can choose from three different salinity scales (practical salinity, natural sea water and percent) and from two temperature compensation modes (linear and natural water).

The enhanced warning system, including acoustic signals is in place to alert users when measuring outside the calibration range. This system will also remind the user when a new calibration is due.

HI 4321 can be used to perform all 3 stages of USP <645> conductivity tests for water quality. The instrument provides clear directions on how to perform each testing stage, automatically monitors the temperature, conductivity and stability during testing and they determines whether a sample is within USP limits.

This unit is equipped with auto standard recognition and can support custom calibration solutions. Obtain up to a 4-point calibration for enhanced accuracy over an extended measuring range.

Features also include real-time graphic displays, on-screen GLP data and a fully customizable SETUP menu. The HI 4321 may also be given a unique ID number. The user can consult the on-board contextual help key from any mode simply by pressing the HELP menu. All the features are available in English, Italian, Portuguese and Spanish. Connect to a PC via the USB or RS232 ports for PC connectivity and access the HI 92000 Windows® compatible data spreadsheet. Equipped with a 12 Vdc power supply.



Features

- 240 x 320 dot matrix color display
- Logging and graphing capabilities
- USB and RS 232 for computer compatibility
- EC, resistivity, TDS and salinity ranges
- Auto recognition of probe type (2 or 4 ring, and nominal cell constant)
- Extended range from 0.001 $\mu\text{S}/\text{cm}$ to 1 S/cm
- Stages 1, 2 and 3 USP mode
- 3 salinity scales: Practical salinity, Natural sea water, Percent
- Linear and natural water temperature compensation

Real Time Logging



HI 4321

Conductivity/TDS Meter

Research Grade Meter with Color Display and USP

SPECIFICATIONS		HI 4321
Conductivity	Range	0.000 to 9.999 μ S/cm; 10.00 to 99.99 μ S/cm; 100.0 to 999.9 μ S/cm; 1.000 to 9.999 mS/cm; 10.00 to 99.99 mS/cm; 100.0 to 999.9 mS/cm; 1000 mS/cm
	Resolution	0.001 μ S/cm; 0.01 μ S/cm; 0.1 μ S/cm; 0.001 mS/cm; 0.01 mS/cm; 0.1 mS/cm; 1 mS/cm
	Accuracy	\pm 1% of reading (\pm 0.01 μ S/cm)
Resistivity	Range	1.00 to 99.99 Ohm-cm; 100.0 to 999.9 Ohm-cm; 1.000 to 9.999 kOhm-cm; 10.00 to 99.99 kOhm-cm; 100.0 to 999.9 kOhm-cm; 1.00 to 9.99 MOhm-cm; 10.0 to 100.0 MOhm-cm
	Resolution	0.01 Ohm-cm; 0.1 Ohm-cm; 0.001 kOhm-cm; 0.01 kOhm-cm; 0.1 kOhm-cm; 0.01 MOhm-cm; 0.1 MOhm-cm
	Accuracy	\pm 2% of reading (\pm 1 Ohm-cm)
TDS	Range	0.000 to 9.999 ppm; 10.00 to 99.99 ppm; 100.0 to 999.9 ppm; 1.000 to 9.999 ppt; 10.00 to 99.99 ppt; 100.0 to 400.0 ppt
	Resolution	0.001 ppm; 0.01 ppm; 0.1 ppm; 0.001 ppt; 0.01 ppt; 0.1 ppt
	Accuracy	\pm 1% of reading (\pm 0.01 ppm)
	Factor	0.40 to 1.00
Salinity	Range	Practical salinity: 0.00 to 42.00; Natural seawater: 0.00 to 80.00 ppt; Percent: 0.0 to 400.0%
	Resolution	0.01 for practical salinity/natural sea water; 0.1% for percent scale
	Accuracy	\pm 1% of reading
Temperature	Range	-20.0 to 120°C; -4.0 to 248.0°F; 253.15 to 393.15K
	Resolution	0.1°C; 0.1°F; 0.1K
	Accuracy	\pm 0.2°C; \pm 0.4°F; \pm 0.2K (excluding probe error)
Calibration	Conductivity	Auto standard recognition, custom calibration solution/4 point calibration
	Salinity	Percent scale—1 point (with HI 7037 standard)
	Temperature	3 points
Temperature Compensation		Linear and non-linear (natural water)
Log-on-demand/Auto Data Logging		10 Lots, 5000 samples per lot/10 Lots, 5000 samples per lot
Auto Endpoint		Yes
PC Connection		Opto-isolated USB and RS232
Display		240 x 320 dot-matrix color LCD with on-screen help, graphing, language selection and custom configuration
Power		12 Vdc adapter (included)
Dimensions/Weight		159 x 230 x 93 mm (6.3 x 9.1 x 3.7)/800 g (1.8 lbs.)



EC USP Mode

HANNA'S HI 4521 and HI 4321 can be used to perform all 3 stages of United States Pharmacopeia testing requirements for water quality (USP <645>).

The instruments give clear instructions on how to perform each stage and automatically check that the temperature, conductivity and stability are within USP limits.

Comprehensive results are shown for all stages on a single screen at the end of the test. Up to 200 reports can be saved for future recall.

ORDERING INFORMATION

HI 4321-02 (230V) and **HI 4321-01** (115V) are supplied with 4-ring EC probe, HI 76404N electrode holder, power adapter and instruction manual.

SOLUTIONS

- HI 7030L** 12880 μ S/cm calibration solution, 500 mL
- HI 7031L** 1413 μ S/cm calibration solution, 500 mL
- HI 7033L** 84 μ S/cm calibration solution, 500 mL
- HI 7034L** 80000 μ S/cm calibration solution, 500 mL
- HI 7035L** 111800 μ S/cm calibration solution, 500 mL
- HI 7039L** 5000 μ S/cm calibration solution, 500 mL

- HI 7037L** Salinity solution, 500 mL
- HI 70300L** Electrode storage solution, 500 mL
- HI 7061L** Electrode cleaning solution, 500 mL

ACCESSORIES

- HI 76404N** Electrode holder
- HI 92000** Windows® compatible software
- HI 920010** RS232 cable for PC connection
- HI 920013** USB cable for PC connection
- HI 180G*** Compact magnetic stirrer with ABS plastic cover, max 1000 rpm, Speedsafe™
- HI 190M*** Magnetic stirrer with ABS plastic cover, max 1000 rpm, Speedsafe™
- HI 200M*** Magnetic stirrer with AISI stainless steel cover, max 1000 rpm, Speedsafe™

* -1: 110/115V, 50/60Hz -2: 220/240V, 50/60Hz



**HI 2300**

Auto-ranging EC, TDS, NaCl, Temperature Meter

*with 4-ring Platinum Probe***Conductivity
Bench Meters**

4 Parameters in One Professional Instrument

HI 2300 performs EC, TDS (Total Dissolved Solids), percentage of NaCl and °C measurements. The auto-ranging feature for EC and TDS measurements sets the highest possible resolution automatically.

All measurements can be temperature compensated at 20 or 25°C. The Automatic Temperature Compensation (ATC) can also be disabled for measuring the actual conductivity and the compensation coefficient can be user selected. The stability indicator located on the LCD ensures accuracy.

Conductivity readings are performed by applying an alternate current to the 4-ring probe, which creates a variable voltage directly proportional to conductivity.

The GLP feature allows users to store and recall data about system status.

To communicate with the PC use the (optional) HI 92000 communication software. This software provides an exclusive online guide of all the commands available and allows data printing, plotting and exporting.

ORDERING INFORMATION

HI 2300-01 (115V) and **HI 2300-02** (230V) are supplied with HI 76310 conductivity probe, 12 Vdc power adapter and instruction manual.

ELECTRODES

HI 76310 4-ring Pt sensor EC probe with built-in temperature sensor and 1 m (3.3') cable

SOLUTIONS

- HI 7030L** 12880 µS/cm calibration solution, 500 mL
- HI 7031L** 1413 µS/cm calibration solution, 500 mL
- HI 7033L** 84 µS/cm calibration solution, 500 mL
- HI 7034L** 80000 µS/cm calibration solution, 500 mL
- HI 7035L** 111800 µS/cm calibration solution, 500 mL
- HI 7039L** 5000 µS/cm calibration solution, 500 mL
- HI 7037L** Salinity solution, 500 mL
- HI 70300L** Electrode storage solution, 500 mL
- HI 7061L** Electrode cleaning solution, 500 mL

ACCESSORIES

- HI 710005** 115 Vac/12 Vdc pwr adapter (US)
- HI 710006** 230 Vac/12 Vdc pwr adapter (EU)
- HI 920010** Cable for PC connection
- HI 92000** Windows® compatible software



- 4-ring EC probe with internal temperature sensor
- Automatic (ATC), Manual (MTC) or No (NoTC) Temperature Compensation
- Auto-ranging
- Good Laboratory Practice
- PC compatible

SPECIFICATIONS		HI 2300
Range	EC	0.00 to 29.99 µS/cm; 30.0 to 299.9 µS/cm; 300 to 2999 µS/cm; 3.00 to 29.99 mS/cm; 30.0 to 200.0 mS/cm; up to 500.0 mS/cm (actual EC)*
	TDS	0.00 to 14.99 mg/L (ppm); 15.0 to 149.9 mg/L (ppm); 150 to 1499 mg/L (ppm); 1.50 to 14.99 g/L (ppt); 15.0 to 100.0 g/L (ppt); up to 400.0 g/L (actual TDS)*, with 0.80 conversion factor
	NaCl	0.0 to 400.0%
	Temperature	-9.9 to 120.0°C
Resolution	EC	0.01 µS/cm; 0.1 µS/cm; 1 µS/cm; 0.01 mS/cm; 0.1 mS/cm
	TDS	0.01 mg/L; 0.1 mg/L; 1 mg/L; 0.01 g/L; 0.1 g/L
	NaCl	0.1%
	Temperature	0.1°C
Accuracy	EC	±1% of reading ± (0.05 µS/cm or 1 digit)
	TDS	±1% of reading ± (0.03 mg/L or 1 digit)
	NaCl	±1% of reading
	Temperature	±0.4°C (excluding probe error)
Calibration	EC	automatic, 1 point with 6 memorized values (84, 1413, 5000, 12880, 80000, 111800 µS/cm)
	NaCl	1 point, with HI 7037 calibration solution
	Temperature	2-point, at 0 and 50°C (32 and 122°F)
Temperature Compensation		automatic or manual, 0 to 60°C (32 and 140°F)
Temperature Coefficient		selectable from 0.00 to 6.00%/°C (EC and TDS only)
TDS Conversion Factor		selectable from 0.40 to 0.80 (default value: 0.50)
Probe (included)		HI 76310, 4-ring platinum, internal temperature sensor
Auto-off		after 5 minutes of non-use (can be disabled)
Power Supply		12 Vdc power adapter (included)
Environment		0 to 50°C (32 to 122°F); RH max 95%
Dimensions/Weight		240 x 182 x 74 mm (9.4 x 7.2 x 2.9") / 1.1 kg (2.4 lbs.)

* with temperature compensation function disabled

HI 216

EC and Resistivity Meter

with 4-ring platinum EC probe and easy to clean resistivity probe



**Add Resistivity
Versatility**

HI 216 is a combination bench meter that can read conductivity in 4 different ranges and resistivity.

For conductivity measurements, the calibration is a simple 1 point procedure using the easy-to-operate front panel knob. The supplied probe does not require re-calibration when switching from one range to another. The 4-platinum-ring probe has a built-in temperature sensor that automatically compensates for temperature changes. The temperature coefficient can be adjusted from 0 to 2.5% using a knob on the front panel.

For resistivity measurements, the meter is factory calibrated and, if necessary, calibration can be adjusted. The HI 3316D resistivity probe is easy to clean and requires little maintenance. It also features a built-in temperature sensor to automatically compensate for temperature variations. The temperature coefficient is user selectable from 2 to 7%.

Both probes use the same DIN plug on the rear panel and the meter automatically recognizes which probe is connected.

- 4 Measurement Ranges
- Simple 1 point EC calibration procedure
- Both probes feature internal temperature sensors
- Low profile and takes little benchspace

SPECIFICATIONS		HI 216
Range	EC	199.9 μ S/cm; 0 to 1999 μ S/cm; 19.99 mS/cm; 199.9 mS/cm
	Resistivity	0 to 19.90 M Ω -cm
Resolution	EC	0.1 μ S/cm; 1 μ S/cm; 0.01 mS/cm; 0.1 mS/cm
	Resistivity	0.10 M Ω -cm
Accuracy (@20°C)	EC	\pm 1% FS
	Resistivity	\pm 2% FS
Calibration	Manual, 1 point, for both EC and resistivity	
Temperature Compensation	Automatic from 0 to 50°C with β selectable from 0 to 2.5%/°C for EC and from 2 to 7%/°C for resistivity	
Probes (included)	HI 76303 for conductivity measurements; HI 3316D for resistivity measurements	
Power Supply	12 Vdc (power adapter included)	
Environment	0 to 50°C (32 to 122°F); RH max 95%	
Dimensions / Weight	240 x 182 x 74 mm (9.4 x 7.1 x 2.9") / 1.0 kg (2.3 lbs.)	

ORDERING INFORMATION

HI 216-01 (115V) and HI 216-02 (230V) are supplied with HI 76303 conductivity probe, HI 3316D resistivity probe, 12 Vdc adapter and instruction manual.

PROBES

HI 76303 Platinum 4-ring conductivity probe with built-in temperature sensor, DIN connector and 1 m (3.3') cable.

HI 3316D Resistivity probe with built-in temperature sensor, DIN connector and 1 m (3.3') cable.

SOLUTIONS

HI 7030L 12880 μ S/cm calibration solution, 500 mL

HI 7031L 1413 μ S/cm calibration solution, 500 mL

HI 7033L 84 μ S/cm calibration solution, 500 mL

HI 7034L 80000 μ S/cm calibration solution, 500 mL

HI 7035L 111800 μ S/cm calibration solution, 500 mL

HI 7039L 5000 μ S/cm calibration solution, 500 mL

HI 70300L Electrode storage solution, 500 mL

HI 7061L Electrode cleaning solution, 500 mL

ACCESSORIES

HI 710005 115 Vac/12 Vdc pwr adapter (US)

HI 710006 230 Vac/12 Vdc pwr adapter (EU)

HI 740036 100 mL plastic beaker (6 pcs)

HI 740034 Cap for 100 mL beaker (6 pcs)

HI 76405 Electrode holder



HI 3316D — Resistivity Probe

EC 214 • EC 215 • EC 215R
Conductivity Meters
for Education

Ideal for Education

EC 214 and EC 215 are bench top multi-range conductivity meters for the laboratory. 4 measurement ranges ensure the highest resolution and precision for your measuring requirements.

1-point calibration is performed manually by adjusting a knob on the front of the meter.

With a user selectable temperature coefficient and a temperature sensor incorporated in the probe, temperature compensation is automatic for the EC 215. The temperature compensation for the EC 214 is manual and the temperature value is set with a knob.

The rugged probe with a 4-ring platinum sensor responds faster than conventional stainless steel models and can be used for measuring highly acidic or alkaline samples even at high temperatures.

In addition, the EC 215R model offers analog output of 0 to 5V that represents the full conductivity scale across all 4 ranges.

- 4 measurement ranges
- 4-ring, platinum conductivity probe with internal temperature sensor
- Analog output (EC 215R)



SPECIFICATIONS		EC 214	EC 215	EC 215R
Range		0.0 to 199.9 $\mu\text{S}/\text{cm}$; 0 to 1999 $\mu\text{S}/\text{cm}$; 0.00 to 19.99 mS/cm ; 0.0 to 199.9 mS/cm		
	Resolution	0.1 $\mu\text{S}/\text{cm}$; 1 $\mu\text{S}/\text{cm}$; 0.01 mS/cm ; 0.1 mS/cm		
Accuracy (@20°C/68°F)		±1% F.S. (excluding probe error)		
	analog output	—	—	±2.5 mV
Calibration		manual, 1 point		
Temperature Compensation		manual, 0 to 50°C (32 to 122°F) with $\beta = 2\%/^{\circ}\text{C}$	automatic, 0 to 50°C (32 to 122°F) with β adjustable from 0 to 2.5%/°C	
Probe		HI 76300, platinum 4-ring sensor, 1 m (3.3') cable (included)	HI 76303, platinum 4-ring sensor, built-in temperature sensor 1 m (3.3') cable (included)	
Analog Output		—	—	0-5 Vcc
Power Supply		12 Vdc (power adapter included)		
Environment		0 to 50°C (32 to 122°F); RH max 95%		
Dimensions		240 x 182 x 74 mm (9.4 x 7.2 x 2.9")		
Weight		1.0 kg (2.2 lbs.)		



ORDERING INFORMATION

EC 214-01 (115V) and **EC 214-02** (230V) are supplied with conductivity probe HI76300, instruction manual and 12 Vdc adapter (HI710005 or HI710006).

EC 215-01 (115V), **EC 215-02** (230V), **EC 215R-01** (115V) and **EC 215R-02** (230V) are supplied with conductivity probe HI76303, instruction manual and 12 Vdc adapter (HI710005 or HI710006).

ELECTRODES

- HI 76300** 4-ring conductivity probe for EC 214
- HI 76303** 4-ring conductivity probe with built-in temperature sensor, for EC 215 and EC 215R

SOLUTIONS

- HI 7030L** 12880 $\mu\text{S}/\text{cm}$ calibration solution, 500 mL
- HI 7031L** 1413 $\mu\text{S}/\text{cm}$ calibration solution, 500 mL
- HI 7033L** 84 $\mu\text{S}/\text{cm}$ calibration solution, 500 mL
- HI 7034L** 80000 $\mu\text{S}/\text{cm}$ calibration solution, 500 mL
- HI 7035L** 111800 $\mu\text{S}/\text{cm}$ calibration solution, 500 mL
- HI 70300L** Electrode storage solution, 500 mL
- HI 7061L** Electrode cleaning solution, 500 mL

ACCESSORIES

- HI 710005** 115 Vac/12 Vdc pwr adapter (US)
- HI 710006** 230 Vac/12 Vdc pwr adapter (EU)
- HI 76404** Probe holder

HI 98188

EC/Resistivity/TDS/NaCl Meter

Waterproof Meter with USP and Backlit Graphic LCD Display



EC Meter with USP

HI 98188 waterproof, portable conductivity meter has an expanded conductivity range from 0.001 $\mu\text{S}/\text{cm}$ to 400 mS/cm , as well as resistivity and 3 salinity scales. This meter automatically recognizes the probe type (2 or 4-ring) and allows the user to adjust the nominal cell constant.

Choose from 7 memorized standards and obtain up to a 5-point calibration. For salinity (% range), HI 7037 standard allows you to make a 1-point calibration. Both linear and natural water temperature compensation are available and the reference temperature is user adjustable. Ten sets of measurement parameters (such as reference temperature, temperature compensation mode, TDS factor, calibration etc.) can be stored as a customized user profile and recalled for later use. HI 98188 is also USP <645> compliant with stages 1, 2 and 3.

Data may be captured by either the log-on-demand option (400 samples) or by interval logging (from 5 sec to 1 minute). Return to the lab and download all data to your PC with the USB connection and HANNA's HI 92000 software. A combination of dedicated and soft keys allows quick, intuitive operation in a choice of languages. Comprehensive GLP data is directly accessible by pressing the GLP key. At the touch of a button access the contextual Help Menu to obtain on-screen information and assistance about each feature.

Designed for field use, this instrument can be easily operated with one hand and is housed in a rugged carrying case. With an extended battery life of up to 100 hours, users are assured long operation time. The inductive charger can either be plugged into a standard 115V or 230V socket with the adapter included or a 12 Vdc source (such as a car's 12V accessory outlet.)

- USP <645> stages 1, 2 and 3
- Autorange from 0.001 $\mu\text{S}/\text{cm}$ to 400 mS/cm
- 2 or 4-ring probe with auto probe recognition
- Memorize up to 10 user profiles
- Linear and natural water temperature compensation
- Three salinity scales
- Interval Logging

Screen Highlights



3 Stage Conformity

This meter can perform all 3 stages of USP <645> water quality testing requirements.

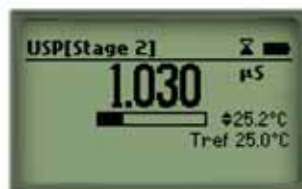

Progress Bar

Meter displays progress towards meeting stage 2 stability requirements.

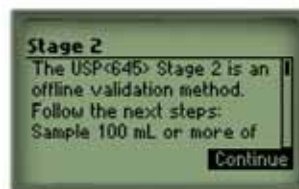

On-screen Guide

Users are provided with on-screen instructions for each USP stage.



User Profiles

10 sets of measurement parameters can be stored in user profiles for later retrieval.

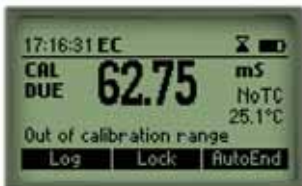

Measurement

Large backlit graphic display shows multiple messages along with the current measurement readings.

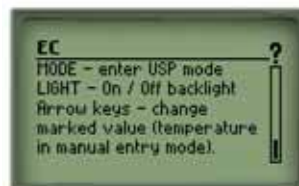

Help

Users can consult the on-screen help from any mode by pressing the HELP key. The instrument will then explain the function and options currently available.

EC/Resistivity/TDS/NaCl Meter

Waterproof Meter with USP and Backlit Graphic LCD Display

Rechargeable batteries with inductive charger

These models have up to 100 hours of extended battery life to guarantee long operation in the field. When the batteries are low, you don't have to worry about carrying a spare set with you—the batteries can be recharged with HANNA's inductive charger. Simply leave the meter on the recharger for a few hours and you're ready to go. The charger can either be plugged into a standard 115V or 230V socket using the included HANNA adapter or a 12 Vdc source (such as a car's 12V accessory outlet).



Specifications		HI 98188
EC	Range	0 to 400mS/cm (actual conductivity 1000 mS/cm) 0.001 to 9.999 µS/cm; 10.00 to 99.99 µS/cm; 100.0 to 999.9 µS/cm; 1.000 to 9.999 mS/cm; 10.00 to 99.99 mS/cm; 100.0 to 1000.0 mS/cm (autoranging)
	Resolution	0.001 µS/cm; 0.01 µS/cm; 0.1 µS/cm; 0.001 mS/cm; 0.01 mS/cm; 0.1 mS/cm
	Accuracy	±1% of reading (±0.01 µS/cm or 1 digit, whichever is greater)
Resistivity	Range	1 to 999.9 Ohm·cm; 1.000 to 9.999 kOhm·cm; 10.00 to 99.99 kOhm·cm; 100.0 to 999.9 kOhm·cm; 1.0 to 100.0 MOhm·cm (autoranging)
	Resolution	0.1 Ohm·cm; 0.001 kOhm·cm; 0.01 kOhm·cm; 0.1 kOhm·cm; 0.1 MOhm·cm
	Accuracy	±2% of reading (±1 Ohm·cm or 1 digit, whichever is greater)
TDS	Range	0.00 to 99.99 ppm; 100.0 to 999.9 ppm; 1.000 to 9.999 g/L; 10.00 to 99.99 g/L; 100.0 to 400.0 g/L (autoranging)
	Resolution	0.01 ppm; 0.1 ppm; 0.001 g/L; 0.01 g/L; 0.1 g/L
	Accuracy	±1% of reading (±0.05 ppm or 1 digit, whichever is greater)
NaCl	Range	%: 0.0 to 400.0%; seawater scale: 0.00 to 80.00 (PSU); Practical salinity: 0.01 to 42.00
	Resolution	0.1%; 0.01
	Accuracy	±1% of reading
Temperature	Range	-20.0 to 120.0°C
	Resolution	0.1°C
	Accuracy	±0.2°C (excluding probe error)
Calibration	EC	Automatic up to 5 points with 7 memorized standards (0.00 µS/cm, 84.0 µS/cm, 1.413 mS/cm, 5.00 mS/cm, 12.88 mS/cm, 80.0 mS/cm, 111.8 mS/cm)
	NaCl	1 point only in % range (with HI 7037 buffer); Use conductivity calibration for all other ranges
	Temperature	1 or 2 points
Temperature Compensation		-20.0 to 120.0°C
Reference Temperature		15°C, 20°C and 25°C
TDS Factor		0.40 to 1.00
Probe		HI 76310 4-ring EC probe with built-in temperature sensor
Logging	Log-on-demand	400 samples
	Interval	5 seconds to 1 minute
PC Connectivity		Opto-isolated USB (with HI 92000 software)
Battery Type/Life		(4) 1.2V AA rechargeable batteries/approx. 100 hrs continuous use (without backlight)
Recharger		HI 710042 inductive charger (included)
Auto-off		User Selectable: 5, 10, 30, 60 min or can be disabled
Environment		IP67
Dimensions / Weight		226.5 x 95 x 52 mm (8.9 x 3.75 x 2") /525 g

ORDERING INFORMATION

HI 98188-01 (115V) and **HI 98188-02** (230V) are supplied with HI 76310 4-ring conductivity probe with built-in temperature sensor, calibration solution, (4) rechargeable batteries, HI 710042 inductive battery charger with power adapter, rugged carrying case and instructions.

PROBES

HI 76310 4-ring EC probe with built-in temperature sensor

SOLUTIONS

- HI 7030L** 12880 µS/cm calibration solution, 500 mL
- HI 7031L** 1413 µS/cm calibration solution, 500 mL
- HI 7033L** 84 µS/cm calibration solution, 500 mL
- HI 7034L** 80000 µS/cm calibration solution, 500 mL
- HI 7035L** 111800 µS/cm calibration solution, 500 mL
- HI 7039L** 5000 µS/cm calibration solution, 500 mL
- HI 7035L** 111800 µS/cm calibration solution, 500 mL
- HI 70442L** 1500 ppm calibration solution, 500 mL
- HI 7036L** 12.41 ppt (g/L) calibration solution, 500 mL
- HI 7037L** Salinity solution, 500 mL
- HI 70300L** Electrode storage solution, 500 mL
- HI 7061L** Electrode cleaning solution, 500 mL

ACCESSORIES

- HI 710042** Inductive charger
- HI 76405** Electrode holder
- HI 92000** Windows® compatible software
- HI 920013** USB cable for PC connection



HI 92000 — PC Software

HI 9835 • HI 98360

EC/TDS/NaCl/°C Meters

Waterproof with 8 EC and TDS Ranges

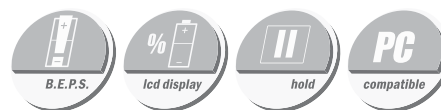

4 Crucial Parameters — One Probe!

HI 9835 and HI 98360 are rugged waterproof conductivity meters, which successfully combine versatility and reliability with ease of use.

HANNA's advanced probe design uses 4 rings enhanced with platinum for greater stability while increasing the range of measurable concentrations and temperature.

The "Auto Endpoint" feature of the HI 98360 makes it the ideal meter for field measurements. After entering this mode, the instrument will automatically freeze stable readings on the LCD for easy recording of measurements.

- 8 EC and TDS ranges
- 4-ring, conductivity probe with built-in temperature sensor
- ATC

SPECIFICATIONS		HI 9835	HI 98360
Range	EC	0.00 to 29.99 $\mu\text{S}/\text{cm}$; 30.0 to 299.9 $\mu\text{S}/\text{cm}$; 300 to 2999 $\mu\text{S}/\text{cm}$; 3.00 to 29.99 mS/cm ; 30.0 to 200.0 mS/cm ; up to 500.0 mS/cm (actual EC)*	
	TDS	0.00 to 14.99 mg/L (ppm); 15.0 to 149.9 mg/L (ppm); 150 to 1499 mg/L (ppm); 1.50 to 14.99 g/L (ppt); 15.0 to 100.0 g/L (ppt); up to 400.0 g/L (actual TDS)*, with 0.80 conversion factor	
	NaCl	0.0 to 400.0%	
	Temperature	0.0 to 60.0°C	-9.9 to 120.0°C**
Resolution	EC	0.01 $\mu\text{S}/\text{cm}$; 0.1 $\mu\text{S}/\text{cm}$; 1 $\mu\text{S}/\text{cm}$; 0.01 mS/cm ; 0.1 mS/cm	
	TDS	0.01 mg/L ; 0.1 mg/L ; 1 mg/L ; 0.01 g/L ; 0.1 g/L	
	NaCl	0.1%	
	Temperature	0.1°C	
Accuracy	EC	$\pm 1\%$ of reading \pm (0.05 $\mu\text{S}/\text{cm}$ or 1 digit)	$\pm 0.5\%$ of reading
	TDS	$\pm 1\%$ of reading \pm (0.03 mg/L or 1 digit)	$\pm 0.5\%$ of reading
	NaCl	$\pm 1\%$ of reading	$\pm 0.5\%$ of reading
	Temperature	$\pm 0.4^\circ\text{C}$ (excluding probe error)	$\pm 0.4^\circ\text{C}$ (excluding probe error)
Calibration	EC	automatic, 1 point with 6 memorized values (84, 1413, 5000, 12880, 80000, 111800 $\mu\text{S}/\text{cm}$)	
	NaCl	1 point, with HI 7037 calibration solution	
	Temperature	2-point, at 0 and 50°C (32 and 122°F)	
Temperature Compensation	automatic or manual, 0 to 60°C (32 to 140°F); can be disabled for measuring actual EC and TDS		
Temperature Coefficient	selectable from 0.00 to 6.00%/°C (EC and TDS only)		
TDS Conversion Factor	selectable from 0.40 to 0.80 (default value: 0.50)		
Data Logging	—		up to 250 samples
PC interface	—		RS 232
Probe (included)	HI 98360: HI 76309/1.5 with built-in temperature sensor and 1.5 m (4.9') cable HI 9835: HI 76309, 4-ring probe with built-in temperature sensor and 1m (3.3') cable		
Power Supply	(4) 1.5V AA batteries (included) or 12 Vdc input; auto-off after 5 minutes of non-use (can be disabled)		
Environment	0 to 50°C (32 to 122°F); RH max 95%		
Dimensions/Weight	196 x 80 x 60 mm (7.7 x 3.1 x 2.4") / 500 g (1.1 lbs.)		

* with temperature compensation function disabled ** using the proper probe

ORDERING INFORMATION

HI 9835 is supplied with HI 76309 conductivity probe, batteries (4), instruction manual and rugged carrying case.

HI 98360 is supplied with HI 76309/1.5 probe with 1.5 m (4.9') cable, batteries, instruction manual and rugged carrying case.

ELECTRODES

HI 76310 Platinum 4-ring conductivity probe with temperature sensor and 1m (3.3') cable.

SOLUTIONS

HI 7030L 12880 $\mu\text{S}/\text{cm}$ calibration solution, 500 mL

HI 7031L 1413 $\mu\text{S}/\text{cm}$ calibration solution, 500 mL

HI 7033L 84 $\mu\text{S}/\text{cm}$ calibration solution, 500 mL

HI 7034L 80000 $\mu\text{S}/\text{cm}$ calibration solution, 500 mL

HI 7035L 111800 $\mu\text{S}/\text{cm}$ calibration solution, 500 mL

HI 7039L 5000 $\mu\text{S}/\text{cm}$ calibration solution, 500 mL

HI 70442L 1500 ppm calibration solution, 500 mL

HI 7036L 12.41 ppt (g/L) calibration solution, 500 mL

HI 7037L Salinity solution, 500 mL

HI 70300L Electrode storage solution, 500 mL

HI 7061L Electrode cleaning solution, 500 mL

ACCESSORIES

HI 710005 115 Vac/12 Vdc pwr adapter (US)

HI 710006 230 Vac/12 Vdc pwr adapter (EU)

HI 92000 Windows® compatible software

HI 920011 Serial cable for PC connection



HI 9033 • HI 9034

EC and TDS Meters

Waterproof, Multi-range with ATC for Field Applications

Conductivity
Portable Meters

Professional Meters Designed for Harsh Conditions

HI 9033 and HI 9034 have proven time and again to hold up under extended use in wet, humid and muddy conditions.

HI 9033 utilizes a single probe and performs conductivity readings in four ranges. Measure samples from deionized water to brine without having to switch or recalibrate the probe.

HI 9034 measures total dissolved solids (TDS) in three ranges and offers the highest accuracy when performing measurements in applications as diverse as HVAC, waste water treatment and reverse osmosis. All three ranges can be activated at the touch of a button without having to change the conductivity probe.

Both meters perform measurements with automatic temperature compensation which adjusts for the effects of temperature on the probe. These portable instruments also feature BEPS (Battery Error Prevention System) technology that switches the meter off when low battery power could affect the readings.

- Multiple conductivity ranges
- Rugged and built to last
- Automatic Temperature Compensation



Specifications	HI 9033	HI 9034
Range	0.0 to 199.9 $\mu\text{S}/\text{cm}$; 0 to 1999 $\mu\text{S}/\text{cm}$; 0.00 to 19.99 mS/cm ; 0.0 to 199.9 mS/cm	0.0 to 199.9 mg/L ; 0 to 1999 mg/L ; 0.00 to 19.99 g/L
Resolution	0.1 $\mu\text{S}/\text{cm}$; 1 $\mu\text{S}/\text{cm}$; 0.01 mS/cm ; 0.1 mS/cm	0.1 mg/L ; 1 mg/L ; 0.01 g/L
Accuracy (@20°C/68°F)	$\pm 1\%$ F.S. (excluding probe error)	
Calibration	manual, 1 point	
Temperature Compensation	automatic, 10 to 50°C (50 to 122°F) with $\beta = 2\%/^{\circ}\text{C}$	
Probe	HI 76302W with internal temperature sensor and 1 m (3.3') cable (included)	
Battery Type / Life	(1) 9V / approx. 100 hours of continuous use	
Environment	0 to 50°C (32 to 122°F); RH max 100%	
Dimensions	196 x 80 x 60 mm (7.7 x 3.1 x 2.4")	
Weight	425 g (0.9 lbs.)	

ORDERING INFORMATION

HI 9033 and HI 9034 is supplied with HI 76302W conductivity probe with 1 m (3.3') screened cable, 9V battery and hard carrying case.

ELECTRODES

HI 76302W 4-ring conductivity probe with built-in temperature sensor and 1 m (3.3') cable

SOLUTIONS

- HI 7030L 12880 $\mu\text{S}/\text{cm}$ calibration solution, 500 mL
- HI 7031L 1413 $\mu\text{S}/\text{cm}$ calibration solution, 500 mL
- HI 7033L 84 $\mu\text{S}/\text{cm}$ calibration solution, 500 mL

- HI 7034L 80000 $\mu\text{S}/\text{cm}$ calibration solution, 500 mL
- HI 7035L 111800 $\mu\text{S}/\text{cm}$ calibration solution, 500 mL
- HI 7032L 1382 ppm (mg/L) calibration solution, 500 mL
- HI 7036L 12.41 ppt (g/L) calibration solution, 500 mL
- HI 70300L Electrode storage solution, 500 mL
- HI 7061L Electrode cleaning solution, 500 mL

ACCESSORIES

- HI 721317 Rugged carrying case



HI 721317 — Carrying Case

HI 87314

EC and Resistivity Meter

Reliable and Waterproof



HI 87314

HI 8732

Specifications		HI 87314	HI 8730	HI 8731	HI 8732
Range	EC	199.9 $\mu\text{S}/\text{cm}$; 1999 $\mu\text{S}/\text{cm}$; 19.99 mS/cm ; 199.9 mS/cm	0 to 1990 $\mu\text{S}/\text{cm}$	0 to 6000 $\mu\text{S}/\text{cm}$	0.00 to 4.00 mS/cm
	TDS	—	0 to 1990 ppm	0 to 3000 ppt	0 to 1999 ppm
	Resistivity	0 to 19.90 $\text{M}\Omega\cdot\text{cm}$	—	—	—
	Temperature	—	0 to 70.0°C		
Resolution	EC	0.1 $\mu\text{S}/\text{cm}$; 1 $\mu\text{S}/\text{cm}$; 0.01 mS/cm ; 0.1 mS/cm	10 $\mu\text{S}/\text{cm}$	10 $\mu\text{S}/\text{cm}$	0.01 mS/cm
	TDS	—	10 ppm	10 ppm	1 ppm
	Resistivity	0.10 $\text{M}\Omega\cdot\text{cm}$	—	—	—
	Temperature	—	1°C	0.1°C	0.1°C
Accuracy (@20°C)	EC/TDS	$\pm 1\%$ FS	$\pm 2\%$ FS.		
	Resistivity	$\pm 2\%$ FS	—		
	Temperature	—	$\pm 1^\circ\text{C}$	$\pm 0.5^\circ\text{C}$	
Calibration	Manual, 1 point, for both EC and resistivity		EC/TDS: Manual 1 point through knob; Temperature: Factory calibrated		
TDS Factor	—		0.5	0.5	Variable, 0.56 to 0.72
Probe (included)	HI 76302W for EC HI 3316D for resistivity		HI 761285		
Temperature Compensation	Automatic from 0 to 50°C with β selectable from 0 to 2.5%/°C for EC and from 2 to 7%/°C for resistivity		Automatic, 0 to 50°C (32 to 122°F) with $\beta=2\%/^\circ\text{C}$		
Environment	0 to 50°C (32 to 122°F); RH max 100%				
Battery Type / Life	(1) 9V (rechargeable) / Approx 100 hours		(1) 9V / approx. 250 hours		
Dimensions/Weight	164 x 76 x 45 mm (6.5 x 3.0 x 1.8") / 250 g (8.8 oz.)				

ORDERING INFORMATION

HI 87314 is supplied with HI 76302W 4-ring conductivity probe, HI 3316D resistivity probe, 9V non-rechargeable battery, calibration screwdriver and instructions.

HI 8730, HI 8731 and **HI 8732** are supplied with conductivity probe with built-in temperature sensor, calibration solution sachets, battery and instructions.

PROBES

HI 76302W 4-ring conductivity probe with built-in temperature sensor, DIN connector and 1 m (3.3') cable

HI 3316D Resistivity probe with built-in temperature sensor, DIN connector and 1 m (3.3') cable

HI 761285 Conductivity probe with built-in temperature sensor, DIN connector and 1 m (3.3') cable

SOLUTIONS

- HI 7030L** 12880 $\mu\text{S}/\text{cm}$ solution, 500 mL
- HI 7031L** 1413 $\mu\text{S}/\text{cm}$ calibration sol., 500 mL
- HI 7033L** 84 $\mu\text{S}/\text{cm}$ calibration sol., 500 mL
- HI 7034L** 80000 $\mu\text{S}/\text{cm}$ calibration sol., 500 mL
- HI 7035L** 111800 $\mu\text{S}/\text{cm}$ calibration sol., 500 mL
- HI 7039L** 5000 $\mu\text{S}/\text{cm}$ calibration sol., 500 mL
- HI 7061L** Probe cleaning solution, 500 mL

ACCESSORIES

- HI 710040** Inductive battery recharger (HI 87314)
- HI 731326** Calibration screwdriver (HI 87314)

EC and Resistivity in a Watertight Enclosure

HI 87314 is a combination, portable meter that can read conductivity in 4 different ranges, and resistivity.

For conductivity measurements, the calibration is a simple 1 point procedure via a trimmer located in the battery compartment. The supplied probe does not require recalibration when switching from one range to another. The 4 (stainless-steel) ring probe has a built-in temperature sensor that automatically compensates for temperature changes.

For resistivity measurements, the meter is factory calibrated and if necessary, calibration can be adjusted.

The HI 3316D resistivity probe is easy to clean and requires little maintenance. It also features a built-in temperature sensor to automatically compensate for temperature variations. The temperature coefficient is user-selectable from 2 to 7%.

Both probes use the same DIN plug on the top of the instrument, and the meter automatically recognizes which probe is connected.

The instrument can be powered by a 9V rechargeable battery and uses an inductive system for battery recharge. There are no external contacts with this system ensuring a watertight seal. The battery can be recharged using the HI 710040 battery charger (optional) without needing to open the meter or remove the battery.

Designed for QC and Production

HI 8730, HI 8731 and HI 8732 are complete, versatile and watertight conductivity meters that are lightweight and easy to maintain.

HI 8730 measures EC in the 0 to 1990 $\mu\text{S}/\text{cm}$ range, TDS from 0 to 1990 ppm, and temperature from 0 to 70°C.

HI 8731 measures EC and TDS with extended ranges (from 0 to 6000 $\mu\text{S}/\text{cm}$ and from 0 to 3000 ppm, respectively) and temperature from 0 to 70°C.

HI 8732 measures EC in the 0 to 4 mS/cm range, TDS from 0 to 1999 ppm and temperature from 0 to 70°C.

TDS and EC Meters

Designed for Measurement Simplicity

Choose from Either TDS or EC Specific Instruments

These EC and TDS portable meters have been designed for simplicity of use and provide accurate measurements.

Readings are automatically compensated for temperature variations, and the calibration is manually performed at one point.

The BEPS (Battery Error Prevention System) automatically switches the meter off when the battery level is too low to ensure reliable readings.

The housing has been completely sealed against humidity, for use in any type of environment.

The probe is easy to clean and requires little maintenance.

Choose the model with the measurement range that best fits your application:

HI 86301 reads TDS from 0 to 1999 ppm (mg/L)

HI 86302 reads TDS from 0.00 to 10.00 ppt (g/L)

HI 86303 reads EC from 0 to 1999 $\mu\text{S}/\text{cm}$

HI 86304 reads EC from 0.00 to 19.99 mS/cm

- Automatic Temperature Compensation
- Probe is easy to maintain and features a built-in temperature sensor



Specifications	HI 86301	HI 86302	HI 86303	HI 86304
Range	0 to 1999 ppm	0.00 to 10.00 ppt	0 to 1999 $\mu\text{S}/\text{cm}$	0.00 to 19.99 mS/cm
Resolution	1 ppm	0.01 ppt	1 $\mu\text{S}/\text{cm}$	0.01 mS/cm
Accuracy (@20°C/68°F)	$\pm 2\%$ F. S.			
Calibration	manual, 1 point, through trimmer			
Calibration Solution	HI 70032	HI 70032	HI 70031	HI 70039
Temperature Compensation	automatic, 5 to 50°C (41 to 122°F) with $\beta=2\%/^{\circ}\text{C}$			
Probe	HI 7634D/1	HI 7632D/1	HI 7634D/1	HI 7632D/1
Battery Type / Life	(1) 9V alkaline / Approx 300 hours	(1) 9V alkaline / Approx 150 hours	(1) 9V alkaline / Approx 300 hours	(1) 9V alkaline / Approx 150 hours
Environment	0 to 50°C (32 to 122°F); RH max 100%			
Dimensions	164 x 76 x 45 mm (6.4 x 3.0 x 1.8")			
Weight	250 g (8.8 oz.)			

ORDERING INFORMATION

HI 86301 and **HI 86303** are supplied with HI 7634D/1 conductivity probe with built-in temperature sensor, calibration solution sachets, battery, screwdriver and instructions.

HI 86302 and **HI 86304** are supplied with HI 7632D/1 conductivity probe with built-in temperature sensor, calibration solution sachets, battery, screwdriver and instructions.

PROBES

HI 7632D/1 Conductivity probe, HR, with built-in temperature sensor, DIN connector and 1 m (3.3') cable

HI 7634D/1 Conductivity probe, LR, with built-in temperature sensor, DIN connector and 1 m (3.3') cable

SOLUTIONS

HI 70031P 1413 $\mu\text{S}/\text{cm}$ solution, 20 mL sachet (25 pcs)
HI 7031M 1413 $\mu\text{S}/\text{cm}$ solution, 250 mL
HI 7031L 1 1413 $\mu\text{S}/\text{cm}$ solution, 500 mL
HI 70032P 1382 ppm solution, 20 mL sachet (25 pcs)
HI 7032M 1382 ppm solution, 250 mL
HI 7032L 1382 ppm solution, 500 mL
HI 70039P 5000 $\mu\text{S}/\text{cm}$ solution, 20 mL sachet (25 pcs)

HI 7039M 5000 $\mu\text{S}/\text{cm}$ solution, 250 mL
HI 7039L 5000 $\mu\text{S}/\text{cm}$ solution, 500 mL
HI 700661P Cleaning solution, general purpose, 20 mL sachet (25 pcs)
HI 7061M Cleaning solution, general purpose, 250 mL
HI 7061L Cleaning solution, general purpose, 500 mL

ACCESSORIES

HI 731326 Calibration screwdriver

Conductivity Calibration Solutions

Quality Solutions for Laboratory Applications



Solutions for All Your Needs

Timely calibration of the instrument/sensor measuring system ensure's correct and reproducible results. HANNA's wide range of conductivity and TDS calibration solutions have been produced to ensure the maximum accuracy.

Easy Calibration

Your conductivity/TDS meter can be calibrated in a few minutes right in your laboratory or in the field. Each label shows the production batch number, expiration date and conductivity/temperature correlation table.

BOTTLES

Code	EC Value @25°C	Size	Package	FDA Bottle	C of A
HI 6031	1413 µS/cm	500 mL	1 bottle		•
HI 6033	84 µS/cm	500 mL	1 bottle		•
HI 7030L	12880 µS/cm	500 mL	1 bottle		
HI 7030M	12880 µS/cm	250 mL	1 bottle		
HI 7030/1G	12880 µS/cm	1 Gallon (3.78 L)	1 bottle		
HI 7031L	1413 µS/cm	500 mL	1 bottle		
HI 7031L/C	1413 µS/cm	500 mL	1 bottle		•
HI 7031M	1413 µS/cm	250 mL	1 bottle		
HI 7031/1G	1413 µS/cm	1 Gallon (3.78 L)	1 bottle		
HI 7033L	84 µS/cm	500 mL	1 bottle		
HI 7033M	84 µS/cm	250 mL	1 bottle		
HI 7034L	80000 µS/cm	500 mL	1 bottle		
HI 7034M	80000 µS/cm	250 mL	1 bottle		
HI 7035L	111800 µS/cm	500 mL	1 bottle		
HI 7035M	111800 µS/cm	250 mL	1 bottle		
HI 7039L	5000 µS/cm	500 mL	1 bottle		
HI 7039M	5000 µS/cm	250 mL	1 bottle		
HI 8030L	12880 µS/cm	500 mL	1 bottle	•	
HI 8031L	1413 µS/cm	500 mL	1 bottle	•	
HI 8033L	84 µS/cm	500 mL	1 bottle	•	
HI 8034L	80000 µS/cm	500 mL	1 bottle	•	
HI 8035L	111800 µS/cm	500 mL	1 bottle	•	
HI 8039L	5000 µS/cm	500 mL	1 bottle	•	

SACHETS

Code	EC Value @25°C	Size	Package	Certificate of Analysis
HI 70030C	12880 µS/cm	20 mL	25 sachets	•
HI 70030P	12880 µS/cm	20 mL	25 sachets	
HI 70031C	1413 µS/cm	20 mL	25 sachets	•
HI 70031P	1413 µS/cm	20 mL	25 sachets	
HI 70033C	84 µS/cm	20 mL	25 sachets	•
HI 70033P	84 µS/cm	20 mL	25 sachets	
HI 70039C	5000 µS/cm	20 mL	25 sachets	•
HI 70039P	5000 µS/cm	20 mL	25 sachets	
HI 77100C	1413 µS/cm & pH 7.01	20 mL	20 sachets (10 ea.)	•
HI 77100P	1413 µS/cm & pH 7.01	20 mL	20 sachets (10 ea.)	

BOTTLES

Code	TDS Value @25°C	Size	Package	Certificate of Analysis
HI 6032	1382 ppm (mg/L)	500 mL	1 bottle	•
HI 7032L	1382 ppm (mg/L)	500 mL	1 bottle	
HI 7032M	1382 ppm (mg/L)	250 mL	1 bottle	
HI 7036L	12.41 ppt (g/L)	500 mL	1 bottle	
HI 7036M	12.41 ppt (g/L)	250 mL	1 bottle	
HI 70442L*	1500 ppm (mg/L)	500 mL	1 bottle	
HI 70442M*	1500 ppm (mg/L)	250 mL	1 bottle	

SACHETS

Code	TDS Value @25°C	Size	Package	Certificate of Analysis
HI 70032C	1382 ppm (mg/L)	20 mL	25 sachets	•
HI 70032P	1382 ppm (mg/L)	20 mL	25 sachets	
HI 70032P/5	1382 ppm (mg/L)	20 mL	500 sachets	
HI 70038C	6.44 ppt (g/L)	20 mL	25 sachets	•
HI 70038P	6.44 ppt (g/L)	20 mL	25 sachets	
HI 70080C	800 ppm (mg/L)	20 mL	25 sachets	•
HI 70080P	800 ppm (mg/L)	20 mL	25 sachets	
HI 70442C*	1500 ppm (mg/L)	20 mL	25 sachets	•
HI 70442P*	1500 ppm (mg/L)	20 mL	25 sachets	
HI 77200C*	1500 ppm (mg/L) & pH 7.01	20 mL	20 sachets (10 ea.)	•
HI 77200P*	1500 ppm (mg/L) & pH 7.01	20 mL	20 sachets (10 ea.)	
HI 77300C	1382 ppm (mg/L) & pH 7.01	20 mL	20 sachets (10 ea.)	•
HI 77300P	1382 ppm (mg/L) & pH 7.01	20 mL	20 sachets (10 ea.)	

TDS Solutions

HANNA is one of the few producers to offer calibration solutions for lab and field applications with packages from 20 to 500 mL. Our packaging has been designed to keep air and light from damaging the calibration solutions.



*TDS Conversion Factor 4-4-2: 0.65 ppm = 1 µS/cm (approximately).



HI 4522 • HI 4521

Research Grade Multiparameter Meters

with Color Display

Multiparameter
Bench Meters

Key Features

- 240 x 320 dot matrix color display
- Simultaneous dual graph display and real-time logging
- USB and RS232 for Computer Compatibility
- Multi-language interface
- GLP data
- Manual or automatic temperature compensation
- Relative mV scale
- Small footprint
- Menu screens are informative and navigation is intuitive
- Electrode Holder (included) holds 3 electrodes and screws securely into the base of the Research Grade Meter series

pH Features

- Exclusive Calibration Check™
- 5 point calibration with standard and custom buffers

ISE Features

- Direct calibration and measurement in multiple units
- Incremental methods: Known addition, Known subtraction, Analyte addition, Analyte subtraction

EC Features

- EC, resistivity, TDS and salinity ranges
- Auto recognition of probe type (2 or 4 ring, and nominal cell constant)
- Extended range from 0.001 $\mu\text{S}/\text{cm}$ to 1 mS/cm
- Stages 1, 2 and 3 USP mode
- 3 salinity scales: Practical salinity, Natural sea water, Percent
- Linear and natural water temperature compensation



Research Grade, Professional Benchtop Instruments

Our new HI 4522 and HI 4521 pH/EC meters feature resistivity, TDS and salinity measuring scales in addition to pH and EC. EC has an extended range from 0.001 $\mu\text{S}/\text{cm}$ to 1 mS/cm with auto recognition of the probe type used. Salinity measurements can be displayed in practical salinity, natural sea water or in percent scale.

These advanced meters also provide 5 point pH calibration with a choice of custom or memorized buffers and provide the user with the exclusive Calibration Check™ diagnostic system.

HI 4522 and HI 4521 feature USP modes for stage 1, 2 or 3. Linear and natural water temperature compensation are also available.

HI 4522 ISE model allows direct calibration and measurement with a choice of units as well as incremental methods.

Both models are equipped with logging, graphing, GLP capabilities and USB plus RS232 ports for PC connectivity and feature 240 x 320 dot-matrix color display with on-screen help, simultaneous graphing, language selection and custom configuration.



Contextual Help Screen

Users can consult the on-screen help from any mode simply by pressing the HELP key. The instrument will then display the meaning and options available of the current screen.

The two measurement channels of the HI 4522 and HI 4521 are galvanically isolated to eliminate noise and instability. In ISE mode, the HI 4522 model provides the user with a choice of several incremental methods. Communication is via opto-isolated USB and RS232 ports.



HI 4522 • HI 4521

Research Grade Multiparameter Meters

with Color Display

SPECIFICATIONS		HI 4522	HI 4521
pH	Range	-2.0 to 20.0; -2.00 to 20.00; -2.000 to 20.000 pH	
	Resolution	0.1 pH; 0.01 pH; 0.001 pH	
	Accuracy	±0.1 pH; ±0.01 pH; ±0.002 pH	
mV	Range	±2000 mV	
	Resolution	0.1 mV	
	Accuracy	±0.2 mV	
ISE	Range	1 x 10 ⁻⁷ to 9.99 x 10 ⁻¹⁰ concentration ±0.2 mV	—
	Resolution	1; 0.1; 0.01 concentration	—
	Accuracy	±0.5% (monovalent ions); ±1% (divalent ions)	—
Conductivity	Range	0.000 to 9.999 µS/cm; 10.00 to 99.99 µS/cm; 100.0 to 999.9 µS/cm; 1.000 to 9.999 mS/cm; 10.00 to 99.99 mS/cm; 100.0 to 999.9 mS/cm; 1000 mS/cm	
	Resolution	0.001 µS/cm; 0.01 µS/cm; 0.1 µS/cm; 0.001 mS/cm; 0.01 mS/cm; 0.1 mS/cm; 1 mS/cm	
	Accuracy	±1% of reading (±0.01 µS/cm)	
Resistivity	Range	1.00 to 99.99 Ohm·cm; 100.0 to 999.9 Ohm·cm; 1.000 to 9.999 kOhm·cm; 10.00 to 99.99 kOhm·cm; 100.0 to 999.9 kOhm·cm; 1.00 to 9.99 MOhm·cm; 10.0 to 100.0 MOhm·cm	
	Resolution	0.01 Ohm·cm; 0.1 Ohm·cm; 0.001 kOhm·cm; 0.01 kOhm·cm; 0.1 kOhm·cm; 0.01 MOhm·cm; 0.1 MOhm·cm	
	Accuracy	±2% of reading (±1 Ohm·cm)	
TDS	Range	0.000 to 9.999 ppm; 10.00 to 99.99 ppm; 100.0 to 999.9 ppm; 1.000 to 9.999 ppt; 10.00 to 99.99 ppt; 100.0 to 400.0 ppt	
	Resolution	0.001 ppm; 0.01 ppm; 0.1 ppm; 0.001 ppt; 0.01 ppt; 0.1 ppt	
	Accuracy	±1% of reading (±0.01 ppm)	
	Factor	0.40 to 1.00	
Salinity	Range	Practical salinity: 0.00 to 42.00; Natural seawater: 0.00 to 80.00 ppt; Percent: 0.0 to 400.0%	
	Resolution	0.01 for practical salinity/natural sea water; 0.1% for percent scale	
	Accuracy	±1% of reading	
Temperature	Range	-20.0 to 120.0°C; -4.0 to 248.0°F; 253.15 to 393.15K	
	Resolution	0.1°C; 0.1°F; 0.1K	
	Accuracy	±0.2°C; ±0.4°F; ±0.2K	
Calibration	pH	Automatic, Up to five-point calibration, 8 standard buffers available (1.68, 3.00, 4.01, 6.86, 7.01, 9.18, 10.01, 12.45), and 5 custom buffers	
	ISE	Automatic, Up to 5 point calibration, 5 fixed standard solutions available for each measurement unit, and 5 custom solutions	—
	Conductivity	Auto standard recognition, custom calibration solution/4 point calibration	
	Salinity	Percent scale—1 point (with HI 7037)	
	Temperature	3 points	
Relative mV Offset Range	±2000 mV		
Input Channel(s)	1 pH/mV /ISE + 1 EC	1 pH/mV + 1 EC	
Calibration Check™	pH electrode and buffer condition		
Temperature Compensation	pH: Automatic or manual from -20.0 to 120.0°C (-4.0 to 248.0°F); EC: Linear and non-linear (natural water)		
Log-on-demand	100 Lots, 5000 samples per lot		
Logging Intervals	1, 2, 5, 10, 30 sec		
PC Connection	Opto-isolated USB and RS232		
Display	240 x 320 dot-matrix color LCD with on-screen help, graphing, language selection and custom configuration		
Power Supply	12 Vdc adapter (included)		
Dimensions/Weight	160 x 231 x 94 mm (6.3 x 9.1 x 3.7")/800 g (1.8 lbs.)		

L C D D i s p l a y
E x a m p l e s

Real Time Logging



Simultaneous Dual-channel Graphing



ORDERING INFORMATION

HI 4521-02 (230V), **HI 4521-01** (115V), **HI 4522-02** (230V) and **HI 4522-01** (115V) are supplied with 4-ring EC probe, glass body pH electrode, temperature probe, power adapter, pH 4 and pH 7 buffer solutions, electrode refilling solution, electrode holder and instructions.

ELECTRODES

- HI 1131B** Refillable pH electrode with BNC connector and 1m (3.3') cable
- HI 7669/2W** Temperature probe

SOLUTIONS

- HI 5004** pH 4.01 buffer solution, 500 mL
- HI 5007** pH 7.01 buffer solution, 500 mL
- HI 5010** pH 10.01 buffer solution, 500 mL
- HI 54710** pH 4.01, pH 7.01 and pH 10.01 buffer solution, 500 mL ea.
- HI 7031L** 1413 µS/cm calibration solution, 500 mL
- HI 7033L** 84 µS/cm calibration solution, 500 mL
- HI 7034L** 80000 µS/cm calibration solution, 500 mL
- HI 7035L** 111800 µS/cm calibration solution, 500 mL
- HI 7039L** 5000 µS/cm calibration solution, 500 mL
- HI 70442L** 1500 ppm calibration solution, 500 mL
- HI 7032L** 1382 ppm (mg/L) calibration solution, 500 mL
- HI 7036L** 12.41 ppt (g/L) calibration solution, 500 mL
- HI 7037L** Salinity solution, 500 mL
- HI 70300L** Electrode storage solution, 500 mL
- HI 7061L** Electrode cleaning solution, 500 mL

ACCESSORIES

- HI 76404N** Electrode holder
- HI 92000** Windows® compatible software
- HI 920013** USB cable for PC connection
- HI 920010** RS232 cable for PC connection

HI 255

EC/TDS/NaCl and pH/mV Meter

for Laboratories

6 in 1 Bench Meter!

The HANNA HI 255 is a logging, microprocessor-based pH, ORP, Conductivity (EC), TDS, NaCl and temperature bench meter. A relative mV feature is also provided.

The autoranging feature of the EC and TDS functions automatically sets the instrument to the scale with the highest possible resolution.

An alarm time-out is available to alert the user that too much time has elapsed since last pH calibration.

- *Autoranging*
- *Good Laboratory Practice*
- *Logging function*
- *PC interface*



ORDERING INFORMATION

HI 255-01 (115V) and **HI 255-02** (230V) are supplied with HI 1131B glass body, combination pH electrode, HI 76310 conductivity /TDS probe, HI 7662 temperature probe, HI 76404 electrode holder, pH 4 and pH 7 buffer solutions, HI 7071S electrolyte solution, 12 Vdc power adapter and instructions.

ELECTRODES

- HI 1131B** Refillable pH electrode with BNC connector and 1m (3.3') cable
- HI 76310** 4-ring platinum sensor conductivity probe
- HI 7662** Temperature probe

SOLUTIONS

- HI 5004** pH 4.01 buffer solution, 500 mL
- HI 5007** pH 7.01 buffer solution, 500 mL
- HI 5010** pH 10.01 buffer solution, 500 mL
- HI 54710** pH 4.01, pH 7.01 and pH 10.01 buffer solution, 500 mL ea.
- HI 7030L** 12880 $\mu\text{S}/\text{cm}$ calibration solution, 500 mL
- HI 7031L** 1413 $\mu\text{S}/\text{cm}$ calibration solution, 500 mL
- HI 7033L** 84 $\mu\text{S}/\text{cm}$ calibration solution, 500 mL
- HI 7034L** 80000 $\mu\text{S}/\text{cm}$ calibration solution, 500 mL
- HI 7035L** 111800 $\mu\text{S}/\text{cm}$ calibration solution, 500 mL
- HI 7037L** Salinity solution, 500 mL
- HI 70300L** Electrode storage solution, 500 mL
- HI 7061L** Electrode cleaning solution, 500 mL

ACCESSORIES

- HI 76404** Electrode holder
- HI 710005** 115 Vac/12 Vdc pwr adapter (US)
- HI 710006** 230 Vac/12 Vdc pwr adapter (EU)
- HI 92000** Windows® compatible software
- HI 920010** Serial cable for PC connection
- HI 190M** Magnetic stirrer with ABS plastic cover, max 1000 rpm, Speedsafe™
- HI 200M** Magnetic stirrer with AISI stainless steel cover, max 1000 rpm, Speedsafe™

SPECIFICATIONS		HI 255
Range	pH/ORP	-2.00 to 16.00 pH; -2.000 to 16.000 pH / ± 699.9 mV; ± 2000 mV
	EC	0.00 to 29.99 $\mu\text{S}/\text{cm}$; 30.0 to 299.9 $\mu\text{S}/\text{cm}$; 300 to 2999 $\mu\text{S}/\text{cm}$ 3.00 to 29.99 mS/cm; 30.0 to 200.0 mS/cm; up to 500.0 mS/cm actual EC*
	TDS	0.00 to 14.99 ppm; 15.0 to 149.9 ppm; 150 to 1499 ppm 1.50 to 14.99 g/L; 15.0 to 100.0 g/L; up to 400.0 g/L actual TDS*
	NaCl	0.0 to 400.0% NaCl
	Temperature	-10 to 120.0 °C (pH); 0.0°C to 60.0°C (EC)
Resolution	pH/ORP	0.01 pH; 0.001 pH/ 0.1 mV (± 699.9 mV); 1 mV (± 2000 mV)
	EC	0.01 $\mu\text{S}/\text{cm}$; 0.1 $\mu\text{S}/\text{cm}$; 1 $\mu\text{S}/\text{cm}$; 0.01 mS/cm; 0.1 mS/cm
	TDS	0.01 ppm; 0.1 ppm; 1 ppm; 0.01 g/L; 0.1 g/L
	NaCl	0.1% NaCl
	Temperature	0.1°C
Accuracy (@20°C)	pH / ORP	± 0.01 pH; ± 0.002 pH/ ± 0.2 mV (± 699.9 mV); ± 1 mV (± 2000 mV)
	EC	$\pm 1\%$ of reading $\pm (0.05 \mu\text{S}/\text{cm}$ or 1 digit)
	TDS	$\pm 1\%$ of reading $\pm (0.03 \text{ ppm}$ or 1 digit)
	NaCl	$\pm 1\%$ of reading
	Temperature	$\pm 0.4^\circ\text{C}$ (excluding probe error)
Relative mV Offset		± 2000 mV
Calibration (pH)		automatic, at 1, 2 or 3 points, with 5 memorized buffers (pH 4.01, 6.86, 7.01, 9.18, 10.01)
Calibration (EC)		automatic, 1 point, with 6 memorized values (84.0 and 1413 $\mu\text{S}/\text{cm}$; 5.00, 12.88, 80.0 and 111.8 mS/cm)
Calibration (NaCl)		automatic, 1 point, with HI 7037L calibration solution
Temperature Compensation		manual or automatic, -10.0 to 120.0°C (14 to 248°F) for pH; 0.0 to 60.0°C (32 to 140°F) for EC (can be disabled for measuring actual EC and TDS values)
Temperature Coefficient		0.00 to 6.00%/°C (EC and TDS only); default value: 1.90%/°C
TDS Conversion Factor		0.40 to 0.80; default value: 0.50
pH Electrode		HI 1131B (included)
EC Probe		HI 76310 (included)
Temperature Probe		HI 7662 (included)
PC Connection		RS232 opto-isolated serial port
Data Logging		200 samples
Input Impedance		10^{12} Ohm
Power Supply		12 Vdc adapter (included)
Environment		0 to 50°C (32 to 122°F); RH max 95%
Dimensions / Weight		240 x 182 x 74 mm (9.4 x 7.2 x 2.9") / 1.1 kg (2.4 lbs.)

* with temperature compensation function disabled

HI 9828

Multiparameter Meter

with Intelligent Probe and Fast Tracker™ — Tag Identification System



Backlit LCD can display up to 12
Measurements at a time



Probe cable available in 4, 10, 20 meter
lengths. Need a different length? Give us a call!

**pH, pH/mV, ORP, % saturation DO,
mg/L DO, EC, absolute EC,
resistivity, TDS, salinity, seawater
specific gravity, atmospheric
pressure, temperature**

HANNA's new HI 9828 is a multiparameter portable instrument that monitors up to 13 different water quality parameters (6 measured, 7 calculated). The meter has a 128 x 64 pixel dot matrix backlit LCD that automatically sizes the digits and allows full configuration of each parameter measured, units and language selection, and on-screen graphing. Each parameter is fully supported by the on-screen context sensitive help, both in the calibration mode and during measurement. For monitoring and recording data, HI 9828 is equipped with HANNA's exclusive Fast Tracker™ – Tag Identification System: iButton®s with unique ID numbers can be installed at any number of sampling sites and are used to record specific location information when logging. The meter incorporates comprehensive GLP features and the downloading of data via USB connection.

Designed for outdoor environments, the meter is impact resistant and waterproof up to IP67 standards (30 minutes immersion under 1 m of water). The multi sensor probe can be left underwater (IP68 standard).

For field calibration, HANNA's Quick Calibration allows users to standardize pH, and conductivity with one solution.



Feature Highlights

- Display up to 12 parameters
- Graphic LCD with backlight
- Meter features IP67 and probe features IP68 waterproof protection
- Exclusive Fast Tracker™—Tag I.D. System simplifies test logging
- Quick Calibration feature
- Built-in barometer
- Measurement check eliminates any erroneous readings
- Auto recognition of pH and ORP probe
- Logger function memorizes the data of all connected sensors
- Log-on-demand and automatic logging (up to 60,000 samples)
- Can display logged data as graphs
- USB for PC connectivity
- Auto-range of EC and TDS readings
- Good Laboratory Practice feature with the latest 5 calibrations recorded
- All sensors are field replaceable
- Meter accepts both alkaline and rechargeable batteries
- Rugged probe with stainless steel tip has a diameter under 2" for wells and pipes

Multiparameter Meter

with Intelligent Probe and Fast Tracker™ — Tag Identification System

Intuitive Configuration, Calibration and Measurement



Fully Configurable Measurement Screen

Calibration

In the field, the Quick Calibration feature verifies probe functionality and calibration with a single calibration solution (HI 9828-25). Simply screw the calibration beaker filled with solution onto the probe, select "Quick calibration" from the menu and press OK. Individual calibration may also be performed using multiple calibration points.

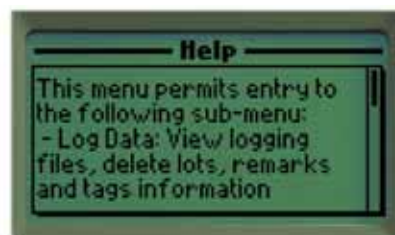
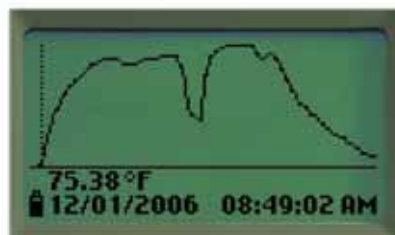
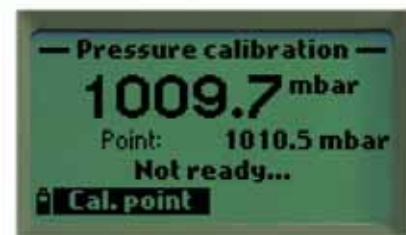
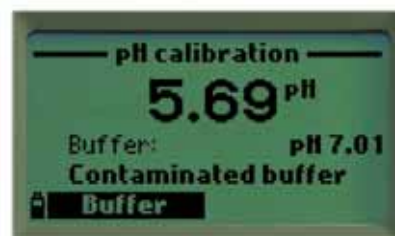
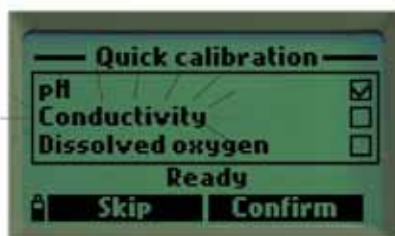

Pressure

Atmospheric pressure calibration and measurement can be made in a choice of units.

Graphing

Trend graphing may be viewed on the display or copied to a PC. Select the Lot to be displayed, select the parameter from a pick list, then OK. The sample date and time stamp will also be displayed.

Help

The context sensitive help screen is always accessible.



Fast Tracker™ Tag Identification System

HANNA's iButton® Tag Identification System simplifies test logging. iButton®s with a unique ID can be installed at various sampling sites. When the matching connector of the meter contacts the button and measurements are logged, they are labeled with the alphanumeric user-entered location ID.

HI 9828

Multiparameter Meter

with Intelligent Probe and Fast Tracker™ — Tag Identification System

HI 769828 multiparameter probe

Sensor replacement is quick and easy with screw type connectors and color coded sensors.

The **galvanic DO sensor** does not require polarization time so it is ready for measurement at a moment's notice.

The **4-ring conductivity system** ensures stable conductivity readings that are immune to surface coating. Absolute conductivity, temperature corrected conductivity, salinity, specific gravity and TDS determinations are possible with measurements from this sensor.

The HI 9828 **automatically recognizes** the presence of either the pH or pH/ORP sensor.

Both sensors have a cloth junction which allows greater sensitivity, and are gel filled for improved resistance to contamination.

The meter also displays pH mV readings—ideal for trouble shooting.

HI 9828 is supplied complete with a probe maintenance kit.

This kit includes HI 7042S (electrolyte solution for DO sensor), (5) O-rings for DO sensor, a small brush, (5) O-rings for multiparameter probe and a syringe with grease to lubricate the O-rings.

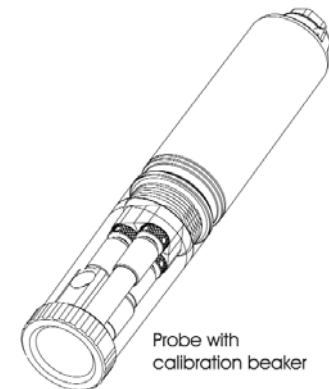
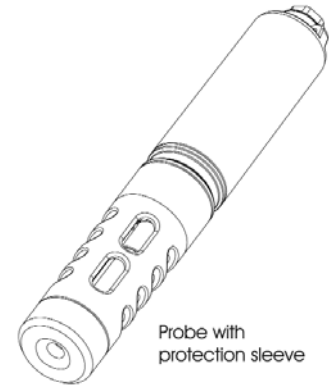
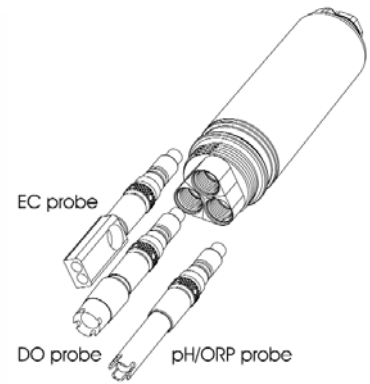

HI 9828's Intelligent Probe

HANNA's HI 769828 multiparameter probe incorporates a built-in microprocessor and amplifiers that convert the high impedance signals from the sensors of the probe eliminating common problems associated with high impedance signals such as limitation of cable length and noise. This allows the probe to have a reliable communication with the meter and also immediately warns the user of problems such as a broken cable. The standard cable lengths of the probe are 4, 10 and 20 meters (13, 32 and 64 feet) and custom lengths are also available.

The probe also features HANNA's Quick Calibration which allows the user to calibrate pH and conductivity with one solution in a single, simple step. Dissolved Oxygen is also calibrated in one step in saturated air. The probe houses 7 of the 8 measured parameters: pH, pH mV, ORP, EC, Absolute EC, % saturation and mg/L (ppm) oxygen, and temperature. The sensors are all independently replaceable and are easy to maintain and keep clean. The sensors are protected by an outer PVC/stainless steel sleeve and cap which is suitable for use in 2" wells. The probe housing is rated IP68 standard.

ORDERING INFORMATION

HI 9828-01 (115V) and **HI 9828-02** (230V) is supplied with HI 769828 multisensor probe (pH/ORP, EC, DO), HI 9828-25 quick calibration standard solution (500 mL), probe maintenance kit, rechargeable C size Ni-MH batteries (5), power adapter & cable, car 12V accessory outlet adapter, HI 7698281 USB interface cable, HI 92000 Windows® compatible software and instruction manual in a rugged carrying case.

x=4, 4 m probe cable
x=10, 10 m probe cable
x=20, 20 m probe cable

HI 9828/

Multiparameter Meter

with Intelligent Probe and Fast Tracker™ — Tag Identification System



Specifications		HI 9828
pH	Range	0.00 to 14.00 pH
	Resolution	0.01 pH
	Accuracy	±0.02 pH
mV of pH input	Range	±600.0 mV
	Resolution	0.1 mV
	Accuracy	±0.5 mV
ORP	Range	±2000.0 mV
	Resolution	0.1 mV
	Accuracy	±1.0 mV
Dissolved Oxygen	Range	0.0 to 500.0% / 0.00 to 50.00 mg/L
	Resolution	0.1% / 0.01 mg/L
	Accuracy	0.0 to 300.0%: ±1.5% of reading or ±1.0% whichever is greater; 300.0 to 500.0%: ±3% of reading; 0.00 to 30.00 mg/L: ±1.5% of reading or 0.10 mg/L whichever is greater; 30.00 mg/L to 50.00 mg/L: ±3% of reading
Conductivity	Range	0.000 to 200.000 mS/cm (actual EC up to 400 mS/cm)
	Resolution	Manual: 1 µS/cm; 0.001 mS/cm; 0.01 mS/cm; 0.1 mS/cm; 1 mS/cm; Automatic: 1 µS/cm from 0 to 9999 µS/cm; 0.01 mS/cm from 10.00 to 99.99 mS/cm; 0.1 mS/cm from 100.0 to 400.0 mS/cm; Automatic mS/cm: 0.001 mS/cm from 0.000 to 9.999 mS/cm; 0.01 mS/cm from 10.00 to 99.99 mS/cm; 0.1 mS/cm from 100.0 to 400.0 mS/cm
	Accuracy	±1% of reading or ±1 µS/cm whichever is greater
Resistivity	Range	0 to 999999 Ω·cm; 0 to 1000.0 kΩ·cm; 0 to 1.0000 MΩ·cm
	Resolution	Dependent on resistivity reading
TDS	Range	0 to 400000 mg/L or ppm (the maximum value depends on the TDS factor)
	Resolution	Manual: 1 mg/L (ppm); 0.001 g/L (ppt); 0.01g/L (ppt); 0.1 g/L (ppt); 1 g/L (ppt); Auto-range scales: 1 mg/L (ppm) from 0 to 9999 mg/L (ppm); 0.01 g/L (ppt) from 10.00 to 99.99 g/L (ppt); 0.1 g/L (ppt) from 100.0 to 400.0 g/L (ppt); Auto-range g/L (ppt) scales: 0.001 g/L (ppt) from 0.000 to 9.999 g/L (ppt); 0.01 g/L (ppt) from 10.00 to 99.99 g/L (ppt); 0.1 g/L (ppt) from 100.0 to 400.0 g/L (ppt)
	Accuracy	±1% of reading or ±1 mg/L
Salinity	Range	0.00 to 70.00 PSU (Practical Salinity Scale)
	Resolution	0.01 PSU
	Accuracy	±2% of reading or 0.01 PSU whichever is greater
Seawater Specific Gravity	Range	0.0 to 50.0 σ _t , σ ₀ , σ ₁₅
	Resolution	0.1 σ _t , σ ₀ , σ ₁₅
	Accuracy	±1 σ _t , σ ₀ , σ ₁₅
Atm. Pressure	Range	450 to 850 mmHg; 17.72 to 33.46 inHg; 600.0 to 1133.2 mbar; 8.702 to 16.436 psi; 0.5921 to 1.1184 atm; 60.00 to 113.32 kPa
	Resolution	0.1 mmHg; 0.01 inHg; 0.1 mbar; 0.001 psi; 0.0001 atm; 0.01 kPa
	Accuracy	±3 mmHg within ±15°C from the temperature during calibration
Temperature	Range	-5.00 to 55.00°C; 23.00 to 131.00°F; 268.15 to 328.15K
	Resolution	0.01°C; 0.01°F; 0.01K
	Accuracy	±0.15°C; ±0.27°F; ±0.15K
Calibration	pH	Automatic 1, 2, or 3 points with 5 memorized standard buffers (pH 4.01, 6.86, 7.01, 9.18, 10.01) or 1 custom buffer
	ORP	Automatic at 1 custom point
	Conductivity, Salinity	Automatic 1 point with 6 memorized standards (84 µS/cm, 1413 µS/cm, 5.00 mS/cm, 12.88 mS/cm, 80.0 mS/cm, 111.8 mS/cm) or custom point
	DO	Automatic 1 or 2 points at 0, 100% or 1 custom point
	Resistivity, TDS, σ	Based on conductivity or salinity calibration
	Atm. Pressure Temperature	Automatic at 1 custom point
Temperature Compensation	Automatic from -5 to 55°C (23 to 131°F)	
Logging Memory	Up to 60000 samples with 13 measurements each	
Logging Interval	1 second to 3 hours	
Computer Interface	USB (with HI 92000 software)	
Waterproof Protection	Meter IP67, Probe IP68	
Environment	0 to 50°C (32 to 122°F); RH 100%	
Power Supply	(4) 1.5V alkaline C cells (approx. 150 hours of continuous use without backlight) / (4) 1.2V rechargeable C cells (approx. 70 hours of continuous use without backlight)	
Dimensions	Meter: 221 x 115 x 55 mm (8.7 x 4.5 x 2.2"); Probe: 270 x 46 mm DIA (10.6 x 1.8" DIA)	
Weight	Meter: 750g (26.5 oz.); Probe: 750g (26.5 oz.)	

PROBES

HI 769828-0 pH sensor, single junction, non refillable

HI 769828-1 pH/ORP sensor

HI 769828-2 DO sensor

HI 769828-3 EC sensor

QUICK CALIBRATION SOLUTIONS

HI 9828-25 Quick calibration solution, 500 mL

HI 9828-27 Quick calibration solution, 1 G

pH CALIBRATION SOLUTIONS

HI 5004 pH 4.01 buffer solution, 500 mL

HI 5007 pH 7.01 buffer solution, 500 mL

HI 5010 pH 10.01 buffer solution, 500 mL

HI 54710 pH 4.01, pH 7.01 and pH 10.01 buffer solution, 500 mL ea.

ORP CALIBRATION SOLUTIONS

HI 7021L ORP test solution @240 mV, 500 mL

HI 7022L ORP test solution @470 mV, 500 mL

DISSOLVED OXYGEN SOLUTIONS

HI 7040L Zero oxygen solution, 500 mL

HI 7042S Electrolyte solution, 30 mL

CONDUCTIVITY CALIBRATION SOLUTIONS

HI 7030L 12880 µS/cm solution, 500 mL

HI 7031L 1413 µS/cm solution, 500 mL

HI 7033L 84 µS/cm solution, 500 mL

HI 7034L 80000 µS/cm solution, 500 mL

HI 7035L 111800 µS/cm solution, 500 mL

HI 7039L 5000 µS/cm solution, 500 mL

TDS CALIBRATION SOLUTIONS

HI 70442L 1500 ppm solution, 500 mL

HI 7032L 1382 ppm (mg/L) solution, 500 mL

HI 7036L 12.41 ppt (g/L) solution, 500 mL

CLEANING AND MAINTENANCE SOLUTIONS

HI 70300L Electrode storage solution, 500 mL

HI 7061L Electrode cleaning solution, 500 mL

ACCESSORIES

HI 7698281 USB interface cable

HI 7698282 Probe maintenance kit

HI 7698283 Calibration beaker

HI 7698284 Flow cell

HI 710045 Power supply cable

HI 710046 Lighter cigarette cable

HI 710005 115 Vac/12 Vdc pwr adapter (US)

HI 710006 230 Vac/12 Vdc pwr adapter (EU)

HI 710012 230 Vac/12 Vdc pwr adapter (UK)

HI 710013 230 Vac/12 Vdc, pwr adapter (S.A.)

HI 710014 230 Vac/12 Vdc, pwr adapter (AUS.)

HI 92000 Software application

HI 920005 iButton® with holder (5 pcs)

HI 991300 • HI 991301

pH/EC/TDS/Temperature Meter

Waterproof with Advanced Features

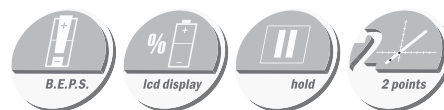

2 Button Operation for Demanding Applications

HANNA offers you a choice of 2 meters to meet your exacting requirements.

HI 991300 and HI 991301 both measure pH, electro-conductivity, total dissolved solids and temperature in a single instrument. To increase precision, you can select the meter which will work best with your range of conductivity—from purified to brackish waters.

There are only 2 buttons, yet you can select from a range of calibration buffers and even the temperature scale (°C or °F) most familiar to you. The housing is waterproof and rated for IP 67 conditions.

The multi-parameter probe, HI 1288, includes pH, EC/TDS and temperature in one convenient, rugged handle.

Other user selectable features include different TDS factors from 0.45 to 1.00, and a range of temperature coefficients (β) from 0.0 to 2.4% for greater consistency and reproducibility. Also selectable are standardized buffer recognition values.

To ensure against interference from transient electrical noise, a solid-state amplifier is integrated into the probe.

- 4 parameters - one probe
- Rugged meter and probe
- Waterproof casing



Specifications		HI 991300	HI 991301
Range	pH	0.00 to 14.00 pH	
	EC	0 to 3999 $\mu\text{S}/\text{cm}$	0.00 to 20.00 mS/cm
	TDS	0 to 2000 ppm (mg/L)	0.00 to 10.00 ppt (g/L)
	Temperature	0.0 to 60.0°C (32.0 to 140.0°F)	
Resolution	pH	0.01 pH	
	EC	1 $\mu\text{S}/\text{cm}$	0.01 mS/cm
	TDS	1 ppm	0.01 ppt
	Temperature	0.1°C (0.1°F)	
Accuracy (@20°C/68°F)	pH	± 0.01 pH	
	EC	$\pm 2\%$ F.S.	
	TDS	$\pm 2\%$ F.S.	
	Temperature	$\pm 0.5^\circ\text{C}$ ($\pm 1.0^\circ\text{F}$)	
TDS Conversion Factor		selectable 0.45 to 1.00 with 0.01 increments (default 0.50)	
pH Calibration		automatic at 1 or 2 points with 2 sets of memorized standard buffers (pH 4.01/7.01/10.01 or pH 4.01/6.86/9.18)	
EC/TDS Calibration		automatic, 1 point at 1382 ppm (CONV=0.5) or at 1500 ppm (CONV=0.7) or at 1413 $\mu\text{S}/\text{cm}$	automatic, 1 point at 6.44 ppt (CONV=0.5) or at 9.02 ppt (CONV=0.7) or at 12880 $\mu\text{S}/\text{cm}$
Temperature Compensation	pH	automatic	
	EC/TDS	automatic with selectable β from 0.0 to 2.4%/°C with 0.1 increments	
Probe		HI 1288, pH/EC/TDS/T, DIN connector, 1 m (3.3') cable (included)	
Battery Type / Life		(4) 1.5V AAA / approximately 500 hours of continuous use	
Environment		0 to 50°C (32 to 122°F); RH max 100%	
Dimensions / Weight		150 x 80 x 36 mm (5.9 x 3.1 x 1.4") / 210g (7.4 oz.)	

ORDERING INFORMATION

HI 991300 and HI 991301 are supplied with HI 1288 probe with 1 m (3.3') cable, batteries, rugged carrying case and instructions.

ELECTRODES

HI 1288 pH/conductivity probe with built-in temperature sensor, DIN connector and 1 m (3.3') cable

SOLUTIONS

HI 5004 pH 4.01 buffer solution, 500 mL

HI 5007 pH 7.01 buffer solution, 500 mL

HI 5010 pH 10.01 buffer solution, 500 mL

HI 54710 pH 4.01, pH 7.01 and pH 10.01 buffer solution, 500 mL ea.

HI 7030L 12880 $\mu\text{S}/\text{cm}$ calibration solution, 500 mL

HI 7031L 1413 $\mu\text{S}/\text{cm}$ calibration solution, 500 mL

HI 7032L 1382 ppm (mg/L) calibration solution, 500 mL

HI 7038L 6.44 ppt calibration solution, 500 mL

HI 70442L 1500 ppm calibration solution, 500 mL

HI 70300L Electrode storage solution, 500 mL

HI 7061L Electrode cleaning solution, 500 mL

ACCESSORIES

HI 710007 Shockproof rubber boot, blue

HI 710008 Shockproof rubber boot, orange



HI 4421

Dissolved Oxygen and BOD Meter

with Graphic, Color LCD Display

Dissolved Oxygen Bench Meters

Advanced Dissolved Oxygen Measurement

HANNA's research grade bench meter line expands to include HI 4421. HI 4421 features DO, BOD, OUR and SOUR measurement modes in a compact versatile instrument. The color 240 x 320 dot matrix LCD is capable of displaying graphs, soft key menus, help screens and calibration reminders. HI 4421 also incorporates an intuitive menu system to help streamline your workflow process and provide accurate measurements quickly and efficiently. Measurements can be uploaded to a PC via USB or RS 232 with HANNA's optional software.



- Extended range up to 90 ppm and 600% saturation
- Barometric atmospheric pressure compensation
- Automatic or user calibration
- Auto-hold to freeze LCD readings
- AutoEnd mode for DO
- Flexible logging with 3 modes
- BOD (biochemical oxygen demand), OUR (oxygen uptake rate) and SOUR (specific oxygen uptake rate)
- GLP
- Two selectable alarm limits
- Up to 100 logging lots, 200 OUR and SOUR reports and up to 200 BOD method entries

SPECIFICATIONS		HI 4421
Range	Dissolved Oxygen	0.00 to 90.00 ppm; 0.0 to 600.0 % saturation
	Barometric Pressure	450 to 850 mmHg; 560 to 1133 mBar
	Salinity Compensation	0 to 45 ppt (g/L)
	Temperature	-20.0 to 120.0°C; -4.0 to 248°F; 253.1 to 393.1 K
Resolution	Dissolved Oxygen	0.01 ppm; 0.1% saturation
	Barometric Pressure	1 mm Hg
	Temperature	0.1°C/°F/K
Accuracy	Dissolved Oxygen	±1.5% of reading ±1 digit
	Barometric Pressure	± 3 mmHg within ±15°C from the calibration point
	Temperature	±0.2°C/K; ±0.4°F
Measurement Modes		Direct DO; BOD (biochemical oxygen demand); OUR (oxygen uptake rate); SOUR (specific oxygen uptake rate)
Calibration	DO	Automatic/user standard, 1 or 2 points
Temperature Compensation		0.0 to 50.0°C; 32.0 to 122.0°F; 237.1 to 323.1 K
Probe (included)		Polarographic with built-in temperature sensor
Logging	Record Samples	Up to 100 lots; 10000 samples/lot for automatic logging; 5000 samples/lot for manual logging
	Logging Interval	1, 2, 5, 10, 30 sec
GLP		Last calibration data, calibration info
Alarm (DO, BOD, OUR, SOUR)		Inside and outside limits
PC Connection		Opto-isolated USB and RS232
Display		240 x 320 dot-matrix color LCD with on-screen help, graphing, language selection and custom configuration
Power Supply		12 Vdc adapter (included)
Dimensions / Weight		159 x 230 x 93 mm (6.3 x 9.1 x 3.7")/800 g (1.8 lbs.)

BOD gives an indication of the biodegradable organic material present in a sample of water. The dissolved oxygen concentration is measured before and after an incubation period of 5 days and the BOD is calculated in mg per liter from the difference.

OUR and **SOUR** are used to determine the oxygen consumption or respiration rate. OUR is measured in mg of oxygen consumed per liter per hour, and SOUR is measured in mg of oxygen consumed per gram of volatile suspended solids per hour.

ORDERING INFORMATION

HI 4421-01 (115V) and **HI 4421-02** (230V) are supplied with HI 76408 DO probe, HI 70415 electrolyte solution (30 mL), HI 76407A membrane caps (2), HI 76404N electrode holder, power adapter and instruction manual.

PROBES

HI 76408 DO probe for laboratory use, with 1 m (3.3') cable

SOLUTIONS

HI 7040M Zero oxygen solution, 230 mL
HI 7040L Zero oxygen solution, 500 mL
HI 7041S Electrolyte solution, 30 mL

ACCESSORIES

HI 76407A/P Replacement membrane (5 pcs)
HI 76404N Electrode holder
HI 92000 Windows® compatible software
HI 920010 Serial cable for PC connection
HI 920013 USB cable for PC connection

HI 2400

Dissolved Oxygen Meter

for Laboratories



For Professional DO Monitoring

For Dissolved Oxygen measurements, HANNA offers the HI 2400—an essential instrument for testing pharmaceutical and food products as well as for monitoring in water treatment plants.

The user can choose to display DO readings in mg/L O₂ or % of saturation.

This meter can be used in any laboratory and for any type of water, as it allows measurement compensation both for altitude and salinity factors.

HI 2400 features an automatic calibration procedures at 1 or 2 points (at 0 and 100% of O₂ saturation).

The automatic logging interval can be set to perform analysis and store data in non-volatile memory.

All logged data can be downloaded to your PC through an RS232 serial port. Memory can store up to 8000 samples.

This meter is supplied with a polarographic sensor which measures the current generated by the reaction of O₂ with Ag, for enhanced stability.

- Automatic calibration
- Altitude, salinity and temperature compensation
- Data logging and storage
- PC compatible
- Polarographic DO probe included

SPECIFICATIONS		HI 2400
Range	DO	0.00 to 45.00 mg/L (ppm)
	% Saturation O ₂	0.0 to 300.0 %
	Temperature	0.0 to 50.0°C
Resolution	DO	0.01 mg/L (ppm)
	% Saturation O ₂	0.1%
	Temperature	0.1°C
Accuracy (@20°C/68°F)	DO	±1.5% F.S.
	% Saturation O ₂	±1.5% F.S.
	Temperature	±0.5°C
DO Calibration	automatic, 1 or 2 points at 0% (with HI 7040 solution) and 100% (in air)	
Altitude Compensation	0 to 4000 m (with 100 m resolution)	
Salinity Compensation	0 to 40 g/L (with 1 g/L resolution)	
Temperature Compensation	automatic, 0.0 to 50.0°C	
Probe	HI 76407/2 with 2 m (6.6') cable (included)	
Logging Interval	1, 15, 30 seconds or 1, 2, 5, 15, 30, 60, 120, 180 minutes	
PC connection	RS232 serial port (opto-isolated)	
Power Supply	12 Vdc adapter	
Environment	0 to 50°C; RH 95%	
Dimensions / Weight	240 x 182 x 74 mm (9.4 x 7.2 x 2.9") / 1.1 kg (2.4 lbs.)	

ORDERING INFORMATION

HI 2400-01 (115V) and **HI 2400-02** (230V) are supplied with HI 76407/2 dissolved oxygen probe with 2 m (6.7') cable, HI 76407A membrane cap (2), HI 70415 electrolyte solution (30 mL), 12 Vdc power adapter and instructions.

PROBES

- HI 76407/2** DO probe, 2 m (6.6') cable
- HI 76407/4** DO probe, 4 m (13') cable
- HI 76407/10** DO probe, 10 m (33') cable
- HI 76407/20** DO probe, 20 m (67') cable

HI 76408 D.O. probe for laboratory use, with 1 m (3.3') cable

SOLUTIONS

- HI 7040M** Zero oxygen solution, 250 mL
- HI 7040L** Zero oxygen solution, 500 mL
- HI 70415** Electrolyte solution, 30 mL

ACCESSORIES

- HI 76407A/P** Replacement membranes (5)
- HI 92000** Windows® compatible software
- HI 920010** Serial cable for PC connection



HI 76407A/P

PTFE Membranes

Carry Extra for Assurance

When the PTFE (PolyTetraFluoro-Ethylene) membrane of the protective cap wears, it is always good to have a back-up.

HI 76407A/P contains 5 ready-to-use, replacement membranes.



HI 98186

Dissolved Oxygen and BOD Meter

with Backlit Graphic LCD Display

Dissolved Oxygen
Portable Meters

Screen Highlights



BOD Parameters and Records

All necessary parameters for BOD testing can be set and displayed at once.

A list of all saved BOD data can be easily retrieved and shown on the LCD display.



BOD Results

BOD is calculated in mg per liter from the difference between the initial and final dissolved oxygen concentration readings.



OUR Results

Measured in mg of oxygen consumed per L per hour.



SOUR Results

Measured in mg of oxygen consumed per g of volatile suspended solids per hour.

BOD gives an indication of the biodegradable organic material present in a sample of water. The dissolved oxygen concentration is measured before and after an incubation period of 5 days and the BOD is calculated in mg per liter from the difference.

OUR and SOUR are used to determine the oxygen consumption or respiration rate. OUR is measured in mg of oxygen consumed per liter per hour, and SOUR is measured in mg of oxygen consumed per gram of volatile suspended solids per hour.

Extended Range

HI 98186 dissolved oxygen meter includes barometric pressure measurement and calibration with a user selectable unit (mmHg, inHg, atm, mbar, psi, kPa) along with salinity, pressure and temperature compensation.

- Extended range up to 50 ppm and 600% saturation
- Barometric pressure measurement
- Salinity, pressure and temperature compensation

Rechargeable batteries with inductive charger



Batteries can be recharged using HANNA's inductive recharger. Simply leave the meter on the charger for a few hours and you're ready to go. The charger can either be powered using the included HANNA adapter or a 12 Vdc source such as a car's 12 V accessory outlet.



SPECIFICATIONS		HI 98186
Range	Dissolved Oxygen	0.00 to 50.00 ppm; 0.0 to 600.0 % saturation
	Barometric Pressure	450 to 850 mmHg
	Salinity Compensation	0 to 70 ppt (g/L)
	Temperature	-20.0 to 120.0°C
Resolution	Dissolved Oxygen	0.01 ppm; 0.1% saturation
	Barometric Pressure	1 mm Hg
	Temperature	0.1°C
Accuracy	Dissolved Oxygen	0 to 300%: ±1.5% of reading or ±1.0%, whichever is greater; 300 to 600%: ±3% of reading; 0 to 30 mg/L: ±1.5% of reading or 0.10 mg/L, whichever is greater; 30 mg/L to 50 mg/L: ±3% of reading
	Barometric Pressure	± 3 mmHg within ±15°C from the calibration point
	Temperature	±0.2°C (excluding probe error)
Measurement Modes		Direct DO; BOD (biochemical oxygen demand); OUR (oxygen uptake rate); SOUR (specific oxygen uptake rate)
Calibration	Dissolved Oxygen	Automatic, 1 or 2 points or manual, 1 point
	Barometric Pressure	1 point
	Temperature	1 or 2 points
Temperature Compensation		Automatic from 0.0 to 50.0°C
Probe		HI 76407/4F Polarographic with built-in temperature sensor + 4m cable
Logging		Log-on-demand 400 samples
PC Connectivity		Opto-isolated USB (with HI 92000 software)
Battery Type/Life		(4) 1.2V AA rechargeable batteries/approx. 200 hrs continuous use (without backlight); HI 710042 inductive recharger (included)
Auto-off		User Selectable: 5, 10, 30, 60 min or can be disabled
Environment / Dimensions / Weight		IP67 / 226.5 x 95 x 52 mm (8.9 x 3.75 x 2") / 525 g (1.1 lbs.)

ORDERING INFORMATION

HI 98186-01 (115V) and HI 98186-02 (230V) are supplied with HI 76407/4F dissolved oxygen probe with built-in temperature sensor and 4 m (13') cable; (2) spare membranes; electrolyte solution; (4) rechargeable batteries; HI 710042 inductive battery charger with power adapter; rugged carrying case and instructions.

PROBES

- HI 76407/10 DO probe with 10 m (33') cable
- HI 76407/20 DO probe with 20 m (67') cable
- HI 76407A/P 5 spare membranes

SOLUTIONS

- HI 7040M Zero oxygen solution, 250 mL
- HI 7040L Zero oxygen solution, 500 mL
- HI 7041S Electrolyte solution, 30 mL

HI 9146 • HI 9143 • HI 9142

Dissolved Oxygen Meters

Designed for Field Applications



HI 9146 Designed for Harsh Conditions

- Extended altitude compensation
- Extended salinity compensation
- Probe and carrying case included

DO Probe features a Protective Sleeve

HI 9143 Extended Range



For Outdoor Use

- Altitude, salinity and temperature compensation
- Designed for the field
- Probe and carrying case included

HI 9142 2 button Operation



Entry-level DO Meter

- Designed for harsh conditions
- ATC
- Affordable and efficient
- Probe and carrying case included

SPECIFICATIONS		HI 9146-04	HI 9146-10	HI 9143	HI 9142
Range	O ₂	0.00 to 45.00 mg/L			0.0 to 19.9 mg/L
	% Saturation O ₂	0.0 to 300.0%			—
	Temperature	0.0 to 50.0°C			—
Resolution	O ₂	0.01 mg/L			0.1 mg/L
	% Saturation O ₂	0.1%			—
	Temperature	0.1°C			—
Accuracy (@ 20°C)	O ₂	±1.5% F.S.			±1.5% F.S.
	% Saturation O ₂	±1.5% F.S.			—
	Temperature	±0.5°C			—
Calibration	automatic, in air, at 100%				manual, at 1 or 2 points (zero & slope)
Temperature Compensation	automatic, 0 to 50°C (32 to 122°F)				—
Altitude Compensation	0 to 4 km (resolution 0.1 km)		0 to 1900 m; 100 m (328') resolution		—
Salinity Compensation	0 to 80 g/L (resolution 1 g/L)		0 to 40 g/L; 1 g/L resolution		—
Probe (included)	HI 76407/4F w/ 4 m cable	HI 76407/10F w/ 10 m cable	HI 76407/4, polarographic, 4 m (13') cable		
Power Supply	(4) 1.5V AA batteries / approx. 200 hours of continuous use; auto-off after 4 hrs of inactivity; or input for 12 Vdc power adapter				(4) 1.5V AA / approx. 500 hours of continuous use
Environment	0 to 50°C (32 to 122°F); RH max 100%				
Dimensions / Weight	196 x 80 x 60 mm (7.7 x 3.1 x 2.4") / 500 g (1.1 lb.)				

ORDERING INFORMATION

HI 9146-04 is supplied complete with HI 76407/4F probe with 4 m (13') cable and protective sleeve, 2 spare membranes, HI 7041S electrolyte solution (30 mL), batteries, hard carrying case and instructions.

HI 9146-10 is supplied complete with HI 76407/10F probe with 10 m (33') cable and protective sleeve, 2 spare membranes, HI 7041S electrolyte solution (30 mL), batteries, hard carrying case and instructions.

HI 9143 is supplied complete with HI 76407/4 probe with 4 m (13') cable, 2 spare membranes, HI 7041S electrolyte solution (30 mL), batteries, rugged carrying case and instructions.

HI 9142 is supplied complete with HI 76407/4 probe with 4 m (13') cable, 2 spare membranes, HI 7041S electrolyte solution (30 mL), calibration screwdriver, batteries, rugged carrying case and instructions.

ACCESSORIES

HI 76407/4F DO probe with 4 m (13') cable and protective sleeve

HI 76407/10F DO probe with 10 m (33') cable and protective sleeve

HI 76407/4 DO Probe with 4 m (13') cable

HI 76407/10 DO Probe with 10 m (33') cable

HI 76407/20 DO Probe with 20 m (67') cable

HI 7040L Zero oxygen solution, 500 mL

HI 7041S Refilling electrolyte solution, 30 mL

HI 76407A/P Replacement membrane, 5 pcs

HI 721317 Hard carrying case



HI 83414 • HI 88703

Precision Turbidity and Free/Total Chlorine Meters

Turbidity Bench Meters



High Accuracy Turbidity Measurement

Turbidity is the optical property that causes light to be scattered and absorbed, rather than transmitted. The scattering of the light that passes through a liquid is primarily caused by the suspended solids. The higher the turbidity, the greater the amount of scattered light. Since molecules in a very pure liquid scatter light to a certain degree, no solution will have zero turbidity. The USEPA Method 180.1 specifies the key parameters for the optical system to measure turbidity for drinking, saline and surface water, in a 0 to 40 NTU range, using the nephelometric method.

HI 83414 and HI 88703 are designed to meet or exceed the criteria specified by the USEPA Method 180.1 and Standard Method 2130 B. The light beam that passes through the sample is scattered in all directions. The intensity and pattern of the scattered light is affected by many variables, such as wavelength of the incident light, particle size and shape, refractive index and color. The optical system includes a tungsten filament lamp, a scattered light detector (90°) and a transmitted light detector (180°).

In the ratio turbidimeter range, the microprocessor of the instrument calculates the NTU value from the signals that reach the two detectors by using an effective algorithm. This algorithm corrects and compensates for interferences of color, making the HI 83414 and HI 88703 color-compensated. The optical system and measuring technique also compensate for the lamp intensity fluctuations—minimizing the need of frequent calibration.

In the non ratio turbidimeter range, the NTU value is calculated from the signal on the scattered light detector (90°). This method offers a high linearity on the low range but is more sensitive to lamp intensity fluctuations.

The lower detection limit of a turbidimeter is determined by stray light. Stray light is the light detected by the sensors that is not caused by light scattering from suspended particles. The optical system of HI 83414 and HI 88703 is designed to have very low stray light, providing accurate results for low turbidity samples.

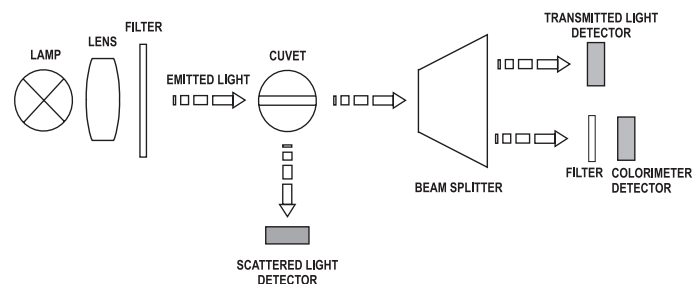

HI 83414 • HI 88703

Precision Turbidity and Free/Total Chlorine Meters

Ideal for Drinking Water Applications

HI 83414 is a highly accurate dual parameter instrument that benefits from HANNA's years of experience. The HI 83414 successfully combines turbidity and colorimetric measurements to test the most important parameters of drinking water: turbidity and free/total chlorine. The meter is especially designed for water quality measurements, providing reliable and accurate readings on low turbidity and chlorine values. The HI 83414 meets and exceeds the requirements of USEPA and Standard Methods both for turbidity and colorimetric measurements.

With the powerful CAL CHECK™ function, reliable performance can be validated at any moment by using the exclusive HANNA ready-made, NIST traceable standards. A one-point calibration can be performed using the same CAL CHECK™ standard.

The HI 88703 measures turbidity only and is especially designed for water quality measurements, providing reliable and accurate readings on low turbidity ranges. The HI 88703 also meets and exceeds the requirements of USEPA and Standard Methods.

These instruments feature a state-of-the-art optical system to guarantee accurate results, assure long term stability and minimize stray light and color interferences. They also compensate for variations in intensity of the lamp for less frequent calibration. The 525 nm interference filter of the colorimeter assures precise and repeatable results. Repeatability of the measurements are ensured with 25 mm round cuvettes made from special optical glass.

Turbidity measurements can be made in the 0.00 to 4000 NTU (Nephelometric Turbidity Units) range when ratiometric

measurements are used and in the 0.00 to 40.0 NTU range when non ratio method is used. These instruments have an EPA compliance reading mode which rounds the reading to meet EPA reporting requirements. Alternative EBC and Nephelos measuring units are available. Depending on the measured sample and needed accuracy, normal measurement, continuous measurement or signal averaging measurement can be selected.

A two, three, four or five-point calibration can be performed by using the supplied (<0.1, 15, 100, 750 and 2000 NTU) standards. If user prepared standards are used, the calibration points can be modified. Free or Total Chlorine measurements can be made in the 0.00 to 5.00 mg/L (ppm) range.

HI 83414 and HI 88703 have complete G.L.P. (Good Laboratory Practice) functions that allow traceability of the calibration conditions. The last calibration points, time and date can be checked.

Both meters incorporate a user-friendly interface with an easy to understand, graphic LCD. All messages are in plain text making them easy to read and understand. Comprehensive contextual help is available at the press of a button. All messages and help screens are available in several languages. Confirmation and error acoustic signals help the user during instrument operation. Furthermore, a tutorial mode of operation guides the user step by step through the analysis process.

The instrument's logging function offers complete information for the measurement. Up to 200 measurements can be stored in the internal memory and consulted at any time. For further storage or analysis options, data can be downloaded to a PC using the USB port.

Features

- *HI 83414 features 4 measuring ranges:*
Ratio Turbidity; Non-Ratio Turbidity;
Free Chlorine; Total Chlorine
- *HI 88703 features 2 measuring ranges:*
Ratio Turbidity; Non-Ratio Turbidity
- *Meets USEPA requirements*
- *Exclusive chlorine CAL CHECK™ calibration validation for HI 83414*
- *Good Laboratory Practice capabilities*
- *2, 3, 4 or 5 point turbidity calibration*
- *USB PC connectivity*
- *Backlit LCD*
- *On-screen tutorial modes*
- *Log and recall up to 200 measurements*
- *Contextual help menus*
- *Auto shut-off*



Precision Turbidity and Free/Total Chlorine Meters

Display Examples

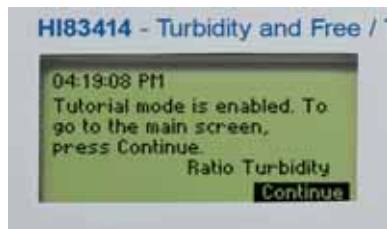

Tutorial Mode

The HI 83414 and HI 88703 have a unique Tutorial Mode that provides additional information to help the inexperienced user during measurements. The instruments display a screen with explanations and confirmation button each time when a preparation or other operation has to be performed by the user. The instrument resumes the measuring sequence when the user confirms that the requested operation was done.



Log and Recall

The HI 83414 has a powerful log function that can store up to 200 records.

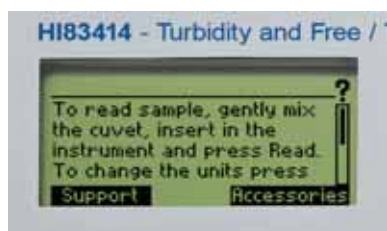

Help Mode

Both meters offer an interactive contextual help mode that assists the user at any moment.

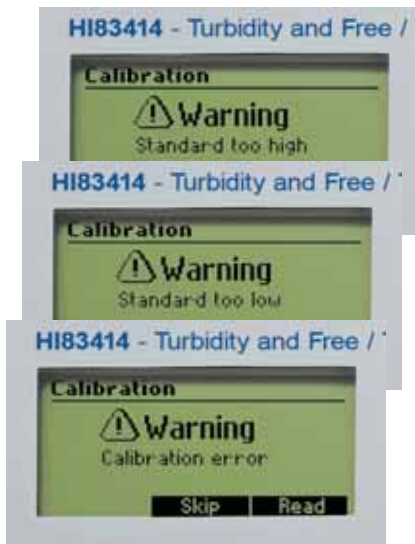

Calibration Error Messages

If the value of the standard read during the calibration is too far from the set value, the instrument will display a standard low or a standard high message.

Check if the correct standard is used or prepare a fresh standard, if formazine is used, and repeat the reading of the standard.

If the calculated calibration coefficients are outside a certain range a calibration error message is displayed.

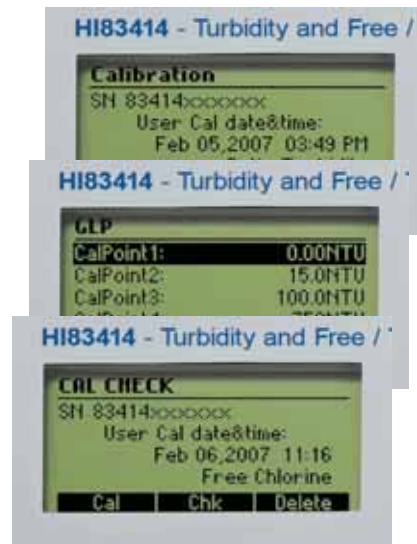
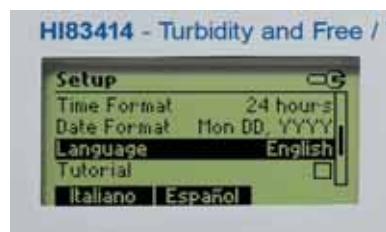

GLP

The HI 83414 has built in complete GLP information. The calibration date and the calibration points are displayed in a comprehensive mode for each range.

To display the GLP information, simply press CAL CHECK key. A screen with instrument serial number and with information about the calibration is displayed. For further information, press the "GLP" functional key.

Language

Press the corresponding function key to change the option. If the new selected language cannot be loaded, the previously selected language will be reloaded.

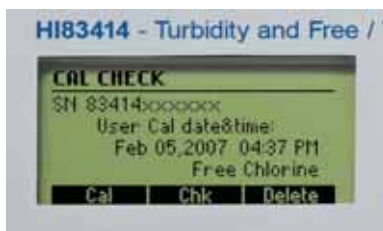

CAL CHECK™

The HI 83414 free and total chlorine colorimeter has a powerful CAL CHECK™ function that allows the user to check the instrument calibration against a NIST traceable standard before making a set of measurements. With the same standard, the instrument could be re-calibrated if necessary.

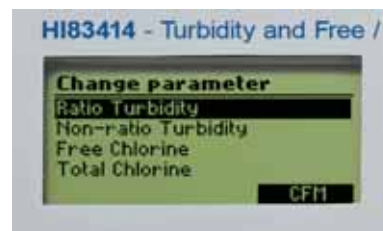

Ranges

The HI 83414 instrument has four measuring ranges: Ratio Turbidity, Non-Ratio Turbidity, Free Chlorine, Total Chlorine. The HI 88703 instrument has two measuring ranges: Ratio Turbidity, Non Ratio Turbidity.

HI 83414 • HI 88703

Precision Turbidity and Free/Total Chlorine Meters

Turbidity Specifications	
Range—Non Ratio Mode	0.00 to 9.99; 10.0 to 40.0 NTU; 0.0 to 99.9; 100 to 268 Nephelos 0.00 to 9.80 EBC
Resolution—Non Ratio Mode	0.01; 0.1 NTU 0.1; 1 Nephelos 0.01 EBC
Range—Ratio Mode	0.00 to 9.99; 10.0 to 99.9; 100 to 4000 NTU 0.0 to 99.9; 100 to 26800 Nephelos 0.00 to 9.99; 10.0 to 99.9; 100 to 980 EBC
Resolution—Ratio Mode	0.01; 0.1; 1 NTU 0.1; 1 Nephelos 0.01; 0.1, 1 EBC
Range Selection	Automatic
Accuracy	±2% of reading plus 0.02 NTU (0.15 Nephelos; 0.01 EBC) ±5% of reading above 1000 NTU (6700 Nephelos; 245 EBC)
Repeatability	±1% of reading or 0.02 NTU (0.15 Nephelos; 0.01 EBC) whichever is greater
Stray Light	< 0.02 NTU (0.15 Nephelos; 0.01 EBC)
Light Detector	Silicon Photocell
Method	Nephelometric method (90°) or Ratio Nephelometric Method (90° & 180°), Adaptation of the USEPA Method 108.1 and Standard Method 2130 B.
Measuring Mode	Normal, Average, Continuous
Turbidity Standards	<0.1, 15, 100, 750 and 2000 NTU
Calibration	Two, three, four or five-point calibration

Free and Total Chlorine Specifications – HI 83414 only	
Range	Free Cl ₂ : 0.00 to 5.00 mg/L Total Cl ₂ : 0.00 to 5.00 mg/L
Resolution	0.01 mg/L from 0.00 to 3.50 mg/L; 0.10 above 3.50 mg/L
Accuracy	±0.02 mg/L @ 1.00 mg/L
Detector	Silicon photocell with 525 nm narrow band interference filters
Method	Adaptation of the USEPA Method 330.5 and Standard Method 4500-Cl G.
Standards	1 mg/L free chlorine, 1 mg/L total chlorine
Calibration	One-point calibration

General Specifications	
Light Source/ Life	Tungsten filament lamp / Greater than 100,000 readings
Display	40 x 70 mm graphic LCD (64 x 28 pixels) with backlight
LOG Memory	200 records
PC Interface	USB
Auto Shut-off	After 15 minutes of non-use
Environment	0°C (32°F) to 50°C (122°F); max 95% RH non-condensing
Power Supply	230 V/50 Hz or 115 V/60 Hz 20 W
Dimensions / Weight	230 x 200 x 145 mm (9 x 7.9 x 5.7") L x W x H / 2.5 Kg (88 oz.)

ORDERING INFORMATION

HI 88703-01 (115 V) and **HI 88703-02** (230 V) are supplied with (5) sample cuvetts and caps, calibration cuvetts, silicone oil (HI 93703-58), tissue for wiping cuvetts, power cord and instruction manual.

HI 83414-01 (115 V) and **HI 83414-02** (230 V) are supplied with (5) sample cuvetts and caps, calibration cuvetts for turbidimeter and colorimeter (HI 83414-11), silicone oil (HI 93703-58), tissue for wiping cuvetts, scissors, power cord and instruction manual.

SOLUTIONS

- HI 93414-11** CAL CHECK™ Calibration set for Free & Total Chlorine
- HI 93701-01** Reagents for 100 Free Chlorine tests
- HI 93701-03** Reagents for 300 Free Chlorine tests
- HI 93711-01** Reagents for 100 Total Chlorine tests
- HI 93711-03** Reagents for 300 Total Chlorine tests
- HI 88703-11** Calibration set for turbidimeter (<0.1, 15, 100 750 and 2000 NTU)
- HI 93703-50** Cuvet cleaning solution, 250 mL

ACCESSORIES

- HI 93703-58** Silicone oil (15 mL)
- HI 731318** Tissue for wiping cuvetts (4)
- HI 731331** Glass cuvetts (4)
- HI 731335N** Caps for cuvetts (4)
- HI 740234** Replacement lamp for EPA turbidimeter
- HI 92000** Windows® compatible software
- HI 920013** USB cable for PC connection

EPA Compliant Turbidity Meters

EPA Compliant Portables that Feature HANNA's Exclusive Fast Tracker™ (T.I.S.) Technology

Fast Tracker™ Tag Identification System (T.I.S.)

HANNA's exclusive Fast Tracker™ — Tag Identification System simplifies test logging while retaining the management versatility users need to search, filter and export data. The system, designed for scientific and industrial applications, helps verify that samples have truly been taken at pre-established locations during safety audits and inspections.

Fast Tracker™ is easy to install and operate. Just place the iButton® tags near your sampling sites that need to be regularly checked. These meters identify and authenticate logged data by storing the iButton® serial number, time and date stamp by simply touching the iButton® with the matching connector on the instruments. The number of tags that can be installed is unlimited and each tag has a unique identification code.

With our HI 92000 Windows® compatible application software, users can sort or filter all collected test data using different criteria such as specific sampling location, parameter, date and time intervals or fixed range to filter measured values. The data can be plotted in a graph, exported to other common Windows® applications or printed for reporting purposes. It is easy to add new tags later on to increase an already existing database.

The HANNA **Fast Tracker™** system is a new revolution in simple and organized data management.



FastTracker™
A new revolution in organized data management

HI 93414, HI 98703 and HI 98713 Turbidity Meters: *Principal of Operation*

Turbidity of the water is an optical property that causes light to be scattered and absorbed, rather than transmitted. The scattering of the light that passes through a liquid is primarily caused by the suspended solids. The higher the turbidity, the greater the amount of scattered light. Because even the molecules in a very pure fluid scatter light to a certain degree, no solution will have zero turbidity.

The USEPA Method 180.1 specifies the key parameters for the optical system to measure turbidity for drinking, saline and surface water in a 0 to 40 NTU range, using the nephelometric method. The HI 93414 and HI 98703 Portable Turbidimeter is designed to meet or exceed the criteria specified by the USEPA Method 180.1 and Standard Method 2130 B.

The ISO 7027 standard specifies the key parameters for the optical system to measure turbidity for drinking and surface water, using the formazin based metric method. The HI 98713 Portable Turbidimeter is designed to meet or exceed the criteria specified by the ISO 7027 standard.

The light beam that passes through the sample is scattered in all directions. The intensity and pattern of the scattered light is affected by many variables like wavelength of the incident light, particle size, shape, refractive index and color.

The HANNA's HI 98703, HI 93414 and HI 98713 are based on a state-of-the-art optical system that guarantee both high performance and reliable results.

HI 93414 and HI 98703's optical system includes a tungsten filament lamp, a scattered light detector (90°) and a transmitted light detector (180°). For the colorimeter range the optical system is based on the turbidimeter tungsten lamp and a separate detector with a narrow band interference filter @ 525 nm to guarantee both high performance and reliable results for colorimetric measurements.

HI 98713's optical system includes an infrared LED, a scattered light detector (90°) and a transmitted light detector (180°). By using an effective algorithm, the instrument's microprocessor calculates the FTU value from the signals that reach the two detectors. This algorithm corrects and compensates for interferences of color, making the HI 98713 turbidimeter color-compensated.

The optical system and measuring technique allow the compensation of lamp intensity (HI 98703, HI 93414) or LED intensity (HI 98713) fluctuations, minimizing the need of frequent calibration.

The lower detection limit of a turbidimeter is determined by the so called "stray light". Stray light is the light detected by the sensors that is not caused by light scattering from suspended particles.

The optical system of HI 98713 turbidimeter is designed to have very low stray light, providing accurate results for low turbidity samples when special care is taken.

HI 93414

Turbidity and Free/Total Chlorine Meter

EPA Compliant Meter that Features HANNA's Exclusive Fast Tracker™ (T.I.S.) and CAL CHECK™



FastTracker™
A new revolution in organized data management

Features

- Tungsten light source—EPA compliant turbidity measurement
- High accuracy at low ranges
- Exclusive chlorine Cal Check™ calibration validation
- Exclusive Fast Tracker™ T.I.S.—Tag Identification System
- User replaceable light source
- 2, 3 or 4 point turbidity calibration
- USB and RS232 PC connectivity
- Backlit LCD
- GLP capability
- User friendly display with guidance codes
- Auto shut-off
- Battery percentage on display
- Continuous current time on display

A Truly Advanced Meter

The HI 93414 combines turbidity and colorimetric measurements to measure the most important parameters of drinking water: turbidity and free/total chlorine. Designed for water quality measurements, HI 93414 provides reliable and accurate readings on low turbidity and chlorine values. The HI 93414 meets and exceeds the requirements of USEPA and Standard Methods both for turbidity and colorimetric measurements.

This instrument incorporates a state-of-the-art optical system which guarantees accurate results. The optical system, consisting of a tungsten filament lamp, three detectors (scattered, transmitted for turbidimeter range and one for colorimeter range), and a narrow band interference filter @ 525 nm assures long term stability and minimizes stray light and color interferences. It also compensates for variations in intensity of the lamp, making no need for frequent calibration. The 25 mm round cuvettes made from special optical glass guarantee the repeatability and consistency of the measurements.

Turbidity measurements can be made in the 0.00 to 1000 NTU (Nephelometric Turbidity Units) range. The instrument has an EPA compliance reading mode which rounds the reading to meet EPA reporting requirements.

Depending on the measured sample and needed accuracy, normal measurement, continuous measurement or signal averaging measurement can be selected. Free or Total Chlorine measurements can be made in the 0.00 to 5.00 mg/L (ppm) range.

With the powerful CAL CHECK™ function, performance of the instrument can be validated at any time by using the exclusive HANNA ready-made NIST traceable standards. Calibration can be performed at any time for turbidity and colorimetric range. For turbidity, a two, three or four-point calibration is available using supplied (<0.1, 15, 100 and 750 NTU adjustable calibration points) or user prepared standards. For colorimeter measurements, a one-point calibration can be performed.

HI 93414 has complete G.L.P. (Good Laboratory Practice) functions that allow traceability of the calibration conditions. The last calibration points, time and date can be checked by a single key touch. HI 93414 has a user-friendly interface with an easy to read, large Liquid Cristal Display. Displayed codes guide the user step by step with routine operation and through calibration. Confirmation and error acoustic signals aid the user during instrument operation.

With its logging function, up to 200 measurements can be stored in internal memory and consulted at any time. Data can be further stored and analyzed by transferring it to a PC via RS232 or USB interface and HANNA software (optional).

For advanced field applications, the HI 93414 is equipped with Fast Tracker™—Tag Identification System (T.I.S.) that makes data collecting and management simpler than ever.



iButton® Tags are Easy to Install

Install TAGs near your sampling points for quick and easy iButton® readings. Each TAG contains a computer chip with a unique identification code encased in stainless steel. You can install a practically unlimited amount of TAGs. Additional TAGs can be ordered for all of your traceability requirements.

Turbidity and Free/Total Chlorine Meter

EPA Compliant Meter that Features HANNA's Exclusive Fast Tracker™ (T.I.S.) and CAL CHECK™

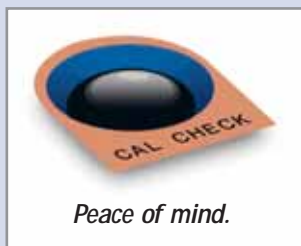

CAL CHECK™ Calibration Validation

With HANNA's exclusive CAL CHECK™ validation function users are able to verify the performance of the instrument at any time. Taking just a few short steps, the validation procedure is user friendly and ensures that the meter is properly

calibrated. Just use the exclusive HANNA ready-made, NIST traceable standards to verify the performance of the instrument and recalibrate if necessary. All instruments are factory calibrated and the electronic and optical design minimizes the need for frequent calibration.

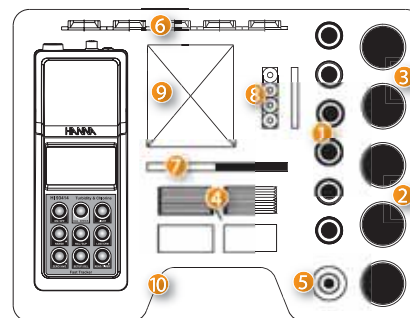

- 1 Five sample cuvettes and caps
- 2 Three calibration cuvettes for turbidimeter
- 3 Two calibration cuvettes for colorimeter*
- 4 Reagent powder packets for F & T chlorine
- 5 Silicone oil
- 6 Five tag holders with tags (HI 920005)
- 7 Scissors
- 8 Batteries (4)
- 9 AC adapter
- 10 Rugged carrying case

Instruction manual

Quick reference guide

Instrument quality certificate

Turbidity	
Range	0.00 to 9.99; 10.0 to 99.9 and 100 to 1000 NTU
Range Selection	Automatic
Resolution	0.01 NTU from 0.00 to 9.99 NTU; 0.1 NTU from 10.0 to 99.9 NTU; 1 NTU from 100 to 1000 NTU
Accuracy	±2% of reading plus 0.02 NTU
Repeatability	±1% of reading or 0.02 NTU, whichever is greater
Stray Light	< 0.02 NTU
Typical EMC Deviation	±0.05 NTU
Light Detector	Silicon Photocell
Method	Ratio Nephelometric Method (90°), ratio of scattered and transmitted light; Adaptation of the USEPA Method 180.1 and Standard Method 2130 B.
Measuring mode	Normal, Average, Continuous
Turbidity Standards	<0.1, 15, 100 and 750 NTU
Calibration	Two, three or four-point calibration

Free and Total Chlorine	
Range	Free Cl ₂ 0.00 to 5.00 mg/L; Total Cl ₂ 0.00 to 5.00 mg/L
Resolution	0.01 mg/L from 0.00 to 3.50 mg/L; 0.10 above 3.50 mg/L
Accuracy	±0.02 mg/L @ 1.00 mg/L
Typical EMC Deviation	±0.02 mg/L
Detector	Silicon photocell with 525 nm narrow band interference filter
Method	Adaptation of the USEPA Method 330.5 and Standard Method 4500-Cl G. The reaction between chlorine and DPD reagent causes a pink tint in the sample.
Standards	1 mg/L free chlorine, 1 mg/L total chlorine
Calibration	One-point calibration

General Specifications	
Light Source	Tungsten filament lamp
Lamp life	Greater than 100,000 readings
LOG Memory	200 records
Serial Interface	USB or RS 232
Environment	Up to 50°C (122°F); max 95% RH non-condensing
Power Supply	(4) 1.5V AA alkaline batteries or AC adapter; Auto-off after 15 minutes of non-use
Dimensions / Weight	224 x 87 x 77 mm (8.8 x 3.4 x 3.0") / 512 g (18 oz.)

ORDERING INFORMATION

HI 93414-01 (115V) and HI 93414-02 (230V) are supplied with sample cuvettes and caps (5), calibration cuvettes for turbidimeter, calibration cuvettes for colorimeter, silicone oil, cuvet wiping tissue, scissors, batteries (4), AC adapter, instruction manual and rugged carrying case.

SOLUTIONS

HI 98703-11 Turbidity standards kit

HI 93703-50 Cuvet cleaning solution, 250 mL

ACCESSORIES

HI 920005 Tag holders with tags (5)

HI 98703-58 Silicone oil (15 mL)

HI 93703-60 Caps for cuvettes (4)

HI 731318 Tissue for wiping cuvettes (4)

HI 731331 Glass cuvettes (4)

HI 92000 Windows® compatible software

HI 920011 5 to 9 pin RS232 connection cable

HI 920013 USB cable for PC connection

HI 98703

EPA Compliant Turbidity Meter

Features HANNA's Exclusive Fast Tracker™ (T.I.S.)



FastTracker™
A new revolution in organized data management.

EPA Compliant Turbidity Measurement

The HI 98703 meets and exceeds the requirements of the USEPA Method 180.1 for wastewater and Standard Method 2130 B for drinking water.

The HI 98703 measures the turbidity of a sample in the 0.00 to 1000 NTU (Nephelometric Turbidity Units) range. An effective algorithm calculates and converts the readings in NTU. The instrument has an EPA compliance reading mode which rounds the reading to meet EPA reporting requirements. Depending on the measured probe and needed accuracy, normal, continuous, or signal averaging measurement can be selected.

HI 98703 has GLP (Good Laboratory Practice) functions that allow traceability of the calibration conditions. The last calibration points, time and date can be checked at any time by a single touch.

HI 98703 has a user-friendly interface with a backlit, easy to read, large LCD (Liquid Crystal Display). The display codes guide the user step by step with routine operation and through calibration.

With its logging function, up to 200 measurements can be stored in the internal memory and consulted at any time. In order to further store and analyze, the data can be downloaded to a PC using by either RS232 or USB.

For advanced field applications, the HI 98703 turbidimeter is equipped with Fast Tracker™—Tag Identification System (T.I.S.) that makes data collecting and management simpler than ever.

- *Tungsten light source—EPA compliant turbidity measurement*
- *High accuracy at low ranges (below 0.05 NTU)*
- *Exclusive Fast Tracker™*
- *2, 3 or 4 point calibration*
- *USB and RS232 PC connectivity*
- *Backlit LCD*
- *GLP capability*
- *User friendly display with guidance codes*
- *Battery percentage on display*
- *Continuous current time on display*

Specifications	HI 98703
Range	0.00 to 9.99; 10.0 to 99.9 and 100 to 1000 NTU
Range Selection	Automatic
Resolution	0.01 NTU from 0.00 to 9.99 NTU; 0.1 NTU from 10.0 to 99.9 NTU; 1 NTU from 100 to 1000 NTU
Accuracy	±2% of reading plus 0.02 NTU
Repeatability	±1% of reading or 0.02 NTU, whichever is greater
Stray Light	< 0.02 NTU
Typical EMC Deviation	±0.05 NTU
Light Detector	Silicon Photocell
Light Source	Tungsten filament lamp
Lamp life	Greater than 100,000 readings
Method	Ratio Nephelometric Method (90°), ratio of scattered and transmitted light; Adaptation of the USEPA Method 180.1 and Standard Method 2130 B.
Measuring mode	Normal, Average, Continuous
Turbidity Standards	<0.1, 15, 100 and 750 NTU
Calibration	Two, three or four-point calibration
LOG Memory	200 records
Serial Interface	USB or RS 232
Environment	Up to 50°C (122°F); max 95% RH non-condensing
Power Supply	(4) 1.5V AA alkaline batteries or AC adapter; Auto-off after 15 minutes of non-use
Dimensions / Weight	224 x 87 x 77 mm (8.8 x 3.4 x 3.0") / 512 g (18 oz.)

ORDERING INFORMATION

HI 98703-01 (115V) and **HI 98703-02** (230V) are supplied with (5) sample cuvetts and caps, HI 98703-11 calibration cuvetts, HI 93703-58 silicone oil, cuvet wiping tissue, (5) HI 920005 tag holders with tags, (4) batteries, AC adapter, instruction manual and rugged carrying case.

SOLUTIONS

HI 98703-11 Turbidity standards kit

HI 93703-50 Cuvet cleaning solution, 250 mL

ACCESSORIES

HI 920005 Tag holders with tags (5)

HI 98703-58 Silicone oil (15 mL)

HI 93703-60 Caps for cuvetts (4)

HI 731318 Tissue for wiping cuvetts (4)

HI 731331 Glass cuvetts (4)

HI 92000 Windows® compatible software

HI 920011 5 to 9 pin RS232 connection cable

HI 920013 USB cable for PC connection

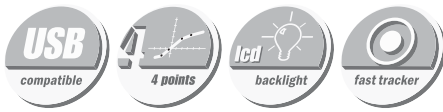

HI 98713

ISO Turbidity Meter

Features HANNA's Exclusive Fast Tracker™ (T.I.S.)

Turbidity
Portable Meters

Designed for Low Turbidity Water Quality Measurements

The HI 98713 measures the turbidity of a sample in the 0.00 to 1000 FNU range. An effective algorithm calculates and converts the detectors output in FNU. Depending on the needed accuracy, normal measurement, continuous measurement, or signal averaging measurement can be selected.

The optical system—The Infrared Method (ISO 7027), consists of an infrared LED and two detectors (scattered and transmitted light), that assures long term stability and minimizes stray light and color interferences. It also compensates for variations in intensity of the LED, minimizing the need for frequent calibration.

The 25 mm round cuvettes made from special optical glass guarantee the repeatability and consistency of the measurements.

HI 98713 has complete GLP (Good Laboratory Practice) functions that allow traceability of the calibration conditions. Last calibration points, time and date can be checked at any time by a single touch.

HI 98713 has a very user-friendly interface, with a backlit, easy to read, large LCD (Liquid Crystal Display). The display codes guide the user step by step with routine operation and calibration.

With the HI 98713's logging function, up to 200 measurements can be stored in the internal memory and consulted at any time. Data can be downloaded to a PC for storing or further analysis through one of the two available ports: RS232 or USB.

For advanced field applications, the HI 98713 turbidimeter is equipped with Fast Tracker™—Tag Identification System (T.I.S.) that makes data collecting and management simpler than ever.



- Exclusive Fast Tracker™
- 2, 3 or 4 point calibration
- USB and RS 232 PC connectivity
- Backlit LCD
- GLP capability
- User friendly display with guidance codes
- Battery percentage on display
- Continuous current time on display



Specifications

Range	0.00 to 9.99; 10.0 to 99.9 and 100 to 1000 FNU
Range Selection	Automatic
Resolution	0.01 FNU from 0.00 to 9.99 FNU; 0.1 FNU from 10.0 to 99.9 FNU; 1 FNU from 100 to 1000 FNU
Accuracy	±2% of reading plus 0.1 FNU
Repeatability	±1% of reading or 0.1 FNU, whichever is greater
Stray Light	< 0.1 FNU
Typical EMC Deviation	±0.05 FNU
IR Detector	Silicon Photocell
Light Source	860 nm infrared LED
Lamp life	Greater than 100,000 readings
Method	Adaptation of ISO 7027, ratio method with 90° and 180° detector.
Turbidity Standards	<0.1, 15, 100 and 750 FNU
Calibration	Two, three or four-point calibration
LOG Memory	200 records
Serial Interface	USB or RS 232
Environment	Up to 50°C (122°F); max 95% RH non-condensing
Power Supply	(4) 1.5V AA alkaline batteries or AC adapter; Auto-off after 15 minutes of non-use
Dimensions / Weight	224 x 87 x 77 mm (8.8 x 3.4 x 3.0") / 512 g (18 oz.)

ORDERING INFORMATION

HI 98713-01 (115V) and **HI 98713-02** (230V) are supplied with (5) sample cuvettes and caps, HI 98713-11 calibration cuvettes, HI 93703-58 silicone oil, cuvet wiping tissue, (4) batteries, AC adapter, instruction manual and rugged carrying case.

SOLUTIONS

HI 98703-11 Turbidity standards kit

HI 93703-50 Cuvet cleaning solution, 250 mL

ACCESSORIES

HI 920005 Tag holders with tags (5)

HI 98703-58 Silicone oil (15 mL)

HI 93703-60 Caps for cuvettes (4)

HI 731318 Tissue for wiping cuvettes (4)

HI 731331 Glass cuvettes (4)

HI 92000 Windows® compatible software

HI 920011 5 to 9 pin RS232 connection cable

HI 920013 USB cable for PC connection



HI 920005 iButton® Tags

HI 83099

COD Meter

Measure COD and 36 Additional Parameters



- **Easy COD measurement**

HI 83099 multi-parameter photometer is pre-calibrated to measure COD levels at three ranges at the touch of a key pad. Simply use the scroll button to select the desired range and begin reading. HI 83099 automatically selects the correct wavelength for the chosen range.

- **Outstanding measurement quality**

HI 83099 employs an advanced optical system, assuring high accuracy measurements in the entire measurement range. The optics combine the power of a miniature light source with the precision of a narrow band interference filter.

- **Save space in your laboratory.**

The compact size of the HI 83099 photometer allows the user to eliminate the clutter of bulkier and more costly spectrophotometers currently being used. Measuring 23 x 17 x 7 cm and weighing less than 700 grams, HI 83099 can be transported with ease from place to place.

A Complete Laboratory at Your Fingertips

This compact photometer operates in three different ranges to cover virtually every COD application: 0-150 mg/L, 0-1500 mg/L and 0-15000 mg/L. The HI 83099 meets the design requirements of USEPA 410.4, guaranteeing high quality measurements suited for reporting purposes.

The HI 83099 can be operated manually or from a PC via the built-in RS232 port and data can be downloaded for analysis and documented with the HI 92000 application software.

HI 83099 is one of the most versatile photometers on the market. In addition to COD, this meter measures up to 36 of the most important water quality parameters.

HI 83099 runs for hours on two common 9V batteries. In addition, it can operate continuously with input voltage of 12 Vdc.

HI 83099 is extremely simple to use. The front mask lists all the parameters in a numerical order and the display shows the same numbers for quick reference during testing.

The meter can be zeroed in seconds and the reagents cost much less than what you may have been paying.

All this and much more at a fraction of the cost of expensive and complex spectrophotometers!

Measurement Procedure

The entire COD measurement process has been designed for ease of use by personnel at any skill level. In addition, all HANNA equipment has been designed for maximum safety during handling and testing with a minimum amount of waste. Even a novice can safely run accurate COD tests in just 3 simple steps:



1. Fill the pre-dosed vial with the sample



2. Place the vial in the HI 839800 reactor (sold separately) and set the timer



3. Place the vial in the HANNA HI 83099 and read the results

HI 83099 COD Meter

for COD and 36 Additional Parameters

Specifications	HI 83099
Light source	4 tungsten lamps with narrow-band interference filters at 420/525/575/610 nm
Light detector	4 silicon photocells
Power supply	(2) 9V batteries or 12 Vdc adapter
Auto-off	after 10 minutes of non-use
Environment	0 to 50°C (32 to 122°F); RH max 95%
Dimensions	230 x 165 x 70 mm
Weight	640 g (1.4 lbs.)

Parameter	Range	Method	Reagent Code‡
Aluminum	0.00 to 1.00 mg/L	Aluminon	HI 93712-01
Ammonia LR	0.00 to 3.00 mg/L	Nessler	HI 93700-01
Ammonia MR	0.00 to 9.99 mg/L	Nessler	HI 93715-01
Bromine	0.00 to 8.00 mg/L	DPD	HI 93716-01
Chlorine, free†	0.00 to 2.50 mg/L	DPD	HI 93701-01
Chlorine, total‡	0.00 to 3.50 mg/L	DPD	HI 93711-01
Chlorine dioxide	0.00 to 2.00 mg/L	Chlorophenol red	HI 93738-01
Chromium VI LR	0 to 300 µg/L	Diphenylcarbohydrazine	HI 93749-01
Chromium VI HR	0 to 1000 µg/L	Diphenylcarbohydrazine	HI 93723-01
COD LR	0 to 150 mg/L	Dichromate EPA*	HI 93754D-25
		Dichromate Hg-free†	HI 93754F-25
		Dichromate ISO**	HI 93754A-25
COD MR	0 to 1500 mg/L	Dichromate EPA*	HI 93754B-25
		Dichromate Hg-free†	HI 93754E-25
		Dichromate ISO**	HI 93754G-25
COD HR	0 to 15000 mg/L	Dichromate	HI 93754C-25
Color	0 to 500 PCU	Platinum Cobalt	—
Copper LR	0 to 990 µg/L	Bicinchoninate	HI 95747-01
Copper HR	0.00 to 5.00 mg/L	Bicinchoninate	HI 93702-01
Cyanide	0.000 to 0.200 mg/L	Pyridine-Pyrazalone	HI 93714-01
Cyanuric acid	0 to 80 mg/L	Turbidimetric	HI 93722-01
Fluoride	0.00 to 2.00 mg/L	SPADNS	HI 93729-01
Hardness (Calcium)	0.00 to 2.70 mg/L	Calmagite	HI 93720-01
Hardness (Magnesium)	0.00 to 2.00 mg/L	EDTA	HI 93719-01
Hydrazine	0 to 400 µg/L	p-Dimethylaminobenzaldehyde	HI 93704-01
Iodine	0.0 to 12.5 mg/L	DPD	HI 93718-01
Iron LR	0 to 400 µg/L	TPTZ	HI 93746-01
Iron HR	0.00 to 5.00 mg/L	Phenantroline	HI 93721-01
Manganese HR	0.0 to 20.0 mg/L	Periodate oxidation	HI 93709-01
Manganese LR	0 to 300 µg/L	PAN	HI 93748-01
Molybdenum	0.0 to 40.0 mg/L	Mercaptoacetic acid	HI 93730-01
Nickel HR	0.00 to 7.00 g/L	Photometric	HI 93726-01
Nitrate	0.0 to 30.0 mg/L	Cadmium reduction	HI 93728-01
Nitrite LR	0.00 to 0.35 mg/L	Diazotiation	HI 93707-01
Nitrite HR	0 to 150 mg/L	Ferrous sulfate	HI 93708-01
Oxygen, dissolved	0.0 to 10.0 mg/L	Winkler	HI 93732-01
pH	6.5 to 8.5 pH	Phenol red	HI 93710-01
Phosphate LR	0.00 to 2.50 mg/L	Ascorbic acid	HI 93713-01
Phosphate HR	0.0 to 30.0 mg/L	Amino acid	HI 93717-01
Phosphorus	0.0 to 15.0 mg/L	Amino acid	HI 93706-01
Silica	0.00 to 2.00 mg/L	Dimolybdate	HI 93705-01
Silver	0.000 to 1.000 mg/L	PAN	HI 93737-01
Zinc	0.00 to 3.00 mg/L	Zincon	HI 93731-01

ORDERING INFORMATION

HI 83099-01 (115V) and **HI 83099-02** (230V) are supplied with 3 glass cuvetts, cell protective cap, batteries, 12 Vdc adapter and instructions.

SOLUTIONS

HI 93703-50 Cuvet cleaning solution, 250 mL

ACCESSORIES

The following accessories and spare parts have been specially designed for COD analysis to make your measurements simpler and safer.

- HI 3898** Test kit for fast analysis of chloride concentration
- HI 839800-01** HANNA instruments® reactor (115 Vac)
- HI 839800-02** HANNA instruments® reactor (230 Vac)
- HI 151-00** Thermometer with stainless steel probe
- HI 710005** 115 Vac / 12 Vdc power adapter
- HI 710006** 230 Vac / 12 Vdc power adapter
- HI 731311** Cuvets with caps for HI 83214
- HI 731318** Tissue for wiping cuvetts (4)
- HI 731321** Measurement cuvet (4)
- HI 731325N** Cuvet cap (4)
- HI 731340** 200 µL automatic pipet
- HI 731341** 1000 µL automatic pipet
- HI 731342** 2000 µL automatic pipet
- HI 731350** Tips for 200 µL automatic pipet (25)
- HI 731351** Tip for 1000 µL automatic pipet (25)
- HI 731352** Tip for 2000 µL automatic pipet (4)
- HI 740216** Test tube cooling rack (25 tube capacity)
- HI 740217** Laboratory bench safety shield
- HI 740219** COD test tube adapter for HI 83099
- HI 92000** Windows® compatible application software
- HI 920010** Serial cable for PC connection (9 pin)



HI 731340 200 µL Automatic Pipette

Notes:

* Method with chromium-sulfuric acid is officially recognized by EPA for wastewater analysis.

** The HI 93754F-25 and HI 93754G-25 method follows the official method ISO 15705.

† This method is recommended for general purpose analysis with no chloride interference.

‡ For chlorine analysis, liquid reagents are also available.

HI 83214

Wastewater COD Meter

Designed for Wastewater Analysis



In the Field ...

An Essential Environmental Tool

The new HI 83214 multi-parameter photometer is a compact instrument featuring different ranges and methods, suitable for a wide range of applications.

HI 83214 is designed and built to perform COD analysis in accordance with EPA 410.4 and ISO 15705:2002 standards.

Ensuring accurate and repeatable results, it is the ideal tool for documenting waste treatment processes.

Besides the fundamental parameter of COD, HI 83214 also measures total ammonia nitrogen and total reactive phosphorus.

The instrument can be connected to a PC through an RS232 serial port and stored measurements can be downloaded using HANNA HI 92000 software.

HI 83214, allows a complete wastewater analysis in a single powerful instrument.

- *Easy COD measurement*

HI 83214 multi-parameter photometer is pre-calibrated to measure COD levels at three ranges at the touch of a key pad. Simply use the scroll button to select the desired range and begin reading. HI 83214 automatically selects the correct wavelength for the chosen range.

- *Outstanding measurement quality*

HI 83214 employs an advanced optical system, assuring high accuracy measurements in the entire measurement range. The optics combine the power of a miniature light source with the precision of a narrow band interference filter.

- *Save space in your laboratory.*

The compact size of the HI 83214 photometer allows the user to eliminate the clutter of bulkier and more costly spectrophotometers currently being used. Measuring 23 x 17 x 7 cm and weighing less than 700 grams, HI 83214 can be transported with ease from place to place.

Measurement Procedure

The entire COD measurement process has been designed for ease of use by personnel at any skill level. In addition, all Hanna equipment has been designed for maximum safety during handling and testing with a minimum amount of waste. Even a novice can safely run accurate COD tests in just 3 simple steps:



1. Fill the pre-dosed vial with the sample



2. Place the vial in the HI 83214 reactor (sold separately) and set the timer



3. Place the vial in the HANNA HI 83214 and read the results

HI 83214

Wastewater COD Meter

Designed for Wastewater Analysis

ORDERING INFORMATION

HI 83214-01 (115V) and HI 83214-02 (230V) are supplied with 5 glass cuvettes, batteries, 12 Vdc adapter and instructions.

SOLUTIONS

HI 93703-50 Cuvet cleaning solution, 250 mL

ACCESSORIES

The following accessories and spare parts have been specially designed for COD analysis to make your measurements simpler and safer.

- HI 3898** Test kit for fast analysis of chloride concentration
- HI 839800-01** HANNA instruments® reactor (115 Vac)
- HI 839800-02** HANNA instruments® reactor (230 Vac)
- HI 151-00** Thermometer with stainless steel probe
- HI 710005** 110 Vac / 12 Vdc power adapter
- HI 710006** 220 Vac / 12 Vdc power adapter
- HI 731310** 9V battery (10)
- HI 731311** Cuvets with caps for HI 83214
- HI 731318** Tissue for wiping cuvetts (4)
- HI 731321** Measurement cuvet (4)
- HI 731325N** Cuvet cap (4)
- HI 731340** 200 µL automatic pipet
- HI 731341** 1000 µL automatic pipet
- HI 731342** 2000 µL automatic pipet
- HI 731350** Tips for 200 µL automatic pipet (25)
- HI 731351** Tip for 1000 µL automatic pipet (25)
- HI 731352** Tip for 2000 µL automatic pipet (4)
- HI 740216** Test tube cooling rack (25 tube capacity)
- HI 740217** Laboratory bench safety shield
- HI 740219** COD test tube adapter for HI 83099
- HI 92000** Windows® compatible application software
- HI 920010** Serial cable for PC connection (9 pin)



... or in the lab.

Specifications	HI 83214
Light Source	3 tungsten lamps with narrow-band interference filters at 420/525/610 nm
Light Detector	3 silicon photocells
Power Supply	2 x 9V batteries or 12 Vdc adapter
Auto-off	after 10 minutes of non-use
Environment	0 to 50°C (32 to 122°F); RH max 95%
Dimensions / Weight	230 x 165 x 70 mm (9.1 x 6.5 x 2.6") / 640 g (1.4 lbs.)

Parameter	Range	Method	Reagent Code
Ammonia, LR	0.00 to 3.00 mg/L	Nessler	HI 93764A-25
Ammonia, HR	0 to 100 mg/L	Nessler	HI 93764B-25
Chlorine, free	0.00 to 5.00 mg/L	DPD	HI 93701-01, HI 93701-03
Chlorine, total	0.00 to 5.00 mg/L	DPD	HI 93711-01, HI 93711-03
Nitrate	0.0 to 30.0 mg/L	Chromotropic acid	HI 93766-50
Nitrogen, total	0.0 to 25.0 mg/L	Chromotropic acid	HI 93767A-50
Nitrogen, total HR	10 to 150 mg/L	Chromotropic acid	HI 93767B-50
COD LR, EPA*	0 to 150 mg/L	Dichromate	HI 93754A-25
COD MR, EPA*	0 to 1500 mg/L	Dichromate	HI 93754B-25
COD HR	0 to 15000 mg/L	Dichromate	HI 93754C-25
COD LR, Mercury-free†	0 to 150 mg/L	Dichromate, mercury-free	HI 93754D-25
COD MR, Mercury-free†	0 to 1500 mg/L	Dichromate, mercury-free	HI 93754E-25
COD LR, ISO**	0 to 150 mg/L	Dichromate	HI 93754F-25
COD MR, ISO**	0 to 1000 mg/L	Dichromate	HI 93754G-25
Phosphorus, reactive	0.00 to 5.00 mg/L	Ascorbic acid	HI 93758A-50
Phosphorus, acid hydrolyzable	0.00 to 5.00 mg/L	Ascorbic acid	HI 93758B-50
Phosphorus, total	0.00 to 3.50 mg/L	Ascorbic acid	HI 93758C-50
Phosphorus, reactive HR	0.0 to 100.0 mg/L	Vanadomolybdophosphoric acid	HI 93763A-50
Phosphorus, total HR	0.0 to 100.0 mg/L	Vanadomolybdophosphoric acid	HI 93763B-50



HI 731340 200 µL Automatic Pipette

Notes:

* Method with chromium-sulfuric acid is officially recognized by EPA for wastewater analysis.

** The HI 93754F-25 and HI 93754G-25 method follows the official method ISO 15705.

† This method is recommended for general purpose analysis with no chloride interference

HI 93754

COD Certified Reagents

in 3 Measurement Ranges



Certified COD Reagents

HANNA COD reagents are available in the following formats:

Code	Method	Range
HI 93754A-25	EPA*	0 to 150 mg/L
HI 93754B-25	EPA*	0 to 1500 mg/L
HI 93754C-25		0 to 15000 mg/L
HI 93754D-25	Mercury-free***	0 to 150 mg/L
HI 93754E-25	Mercury-free***	0 to 1500 mg/L
HI 93754F-25	ISO**	0 to 150 mg/L
HI 93754G-25	ISO**	0 to 1000 mg/L

Each box of 25 vials is supplied with a HANNA certificate of quality.

The reagents are traceable to NIST SRM® 930.

HANNA also produces mercury-free reagents to be used for analyzing samples without chloride.



- *Three measurement ranges to satisfy each need*

As COD levels vary depending on the application and process measuring points, HANNA offers reagents to cover three separate ranges. Simply choose the best range for your application:

low range: 0 to 150 mg/L O₂

medium range: 0 to 1500 mg/L or 0 to 1000 mg/L O₂

high range: 0 to 15000 mg/L O₂

- *Accurate and repeatable measurements*

HANNA COD reagents have been developed in accordance with Standard Methods 5220D, USEPA 410.4 and ISO15705:2002 methods.

- *Pre-dosed vials*

HANNA vial contains approx. 3 mL of pre-dosed reagent. The operator just needs to add a small quantity of the sample - 2 mL for LR and MR, and 0.2 mL for HR analysis.

- *Quick and accurate measurements*

With pre-dosed vials test preparation time is dramatically reduced. There is no time-consuming reagent preparation procedure or glassware cleaning.

- *Safe reagents*

HANNA COD reagents are safe for operators and the environment. Vials and caps have been designed to avoid accidental reagent spills. Thanks to the pre-dosed reagents, the amount of chemicals is minimized.



HI 740216 Test Tube Cooling Rack

Notes:

* Method with chromium-sulfuric acid is officially recognized by EPA for wastewater analysis.

** The HI 93754F-25 and HI 93754G-25 method follows the official method ISO 15705.

*** This method is recommended for general purpose analysis with no chloride interference.

HI 3898 Chloride Test Kit

Quick Chloride Tests

The HI 3898 test kit, developed according to the ISO 15705:2002 method, determines chloride concentration.

This very important test is recommended by ISO, as an excessive presence of chloride can interfere with the COD official analysis method.

The test gives a fast YES/NO reply to the question if chloride interferes with COD analysis: if chloride concentration is greater than the official maximum level, the solution turns yellow and the sample needs to be diluted before performing the COD test, otherwise if the solution is orange-brown, the sample doesn't need to be diluted.

The maximum level allowed is 1000 ppm of Cl⁻ following ISO methods, or 2000 ppm of Cl⁻ for US EPA, APHA, AWWA and WEF methods.



Specifications	HI 3898
Range	1000 ppm Cl ⁻ (ISO) 2000 ppm Cl ⁻ (EPA)
Analysis Method	visual evaluation
Sample Volume	2 mL
Number of Tests	100
Dimensions	120 x 110 x 90 mm (4.7 x 4.3 x 3.5")
Weight	200 g (7.0 oz.)

ORDERING INFORMATION

HI 3898 is supplied with HI 3898-0 Reagent 25 mL (4), Chloride Indicator 7 mL (1), glass cuvet with plastic stopper (1) and calibrated syringes of 1.0 ml with tip (2).

SOLUTIONS

HI 93703-50 Cuvet cleaning solution (250 mL)

ACCESSORIES

- HI 731342** 2000 µL automatic pipet
- HI 731352** Tips for 2000 µL automatic pipet (4)
- HI 740142** 1 mL graduated syringe
- HI 740143** 1 mL graduated syringes (6)
- HI 740144** Tips for 1 mL graduated syringes (6)
- HI 731318** Tissues for wiping cuvettes (4)
- HI 731331** Large cuvettes (4)
- HI 731335** Cap for large cuvettes (4)

HI 839800 COD Test Tube Heater

with 25 Vial Capacity

COD
Reactor, CTK



Outer casing stays cool to the touch!

Accuracy and Safety

HANNA HI 839800 thermo-reactor is constructed of durable materials with a vial capacity to perform up to 25 digestions simultaneously. The reactor is equipped with a user selectable temperature setting to allow for COD and total phosphorus reactions at 150°C and also 105°C for total nitrogen analysis.

To ensure the highest accuracy during digestion, a timer up to 120 minutes is incorporated into the meter. An audible alarm indicates when the incubating period is complete. HI 839800 is also equipped with an ON/OFF LED and a heating LED which advises the user when the selected temperature has been reached.

For added safety, an auto-off feature together with an internal temperature sensor prevents over-heating of the samples.

Specifications	HI 839800
Temperature of Reaction	selectable, 105°C or 150°C
Temperature Stability	±0.5°C
Capacity	25 vials (dia 16 x 100 mm, 0.6 x 3.9"), 1 receptacle for a reference thermometer with stainless steel probe
Accuracy	±2°C (@25°C/77°F)
Warm-up Time	approx. 30 minutes, depending on selected temperature
Operating Mode	timed (0 to 120 minutes) or infinity mode
Timer	0 to 120 minutes with acoustic alarm and automatic shut-off
Block	aluminum
Environment	5 to 50°C (41 to 122°F)
Power Supply (fuse protected)	100 Vac, 50/60Hz; 230 Vac; 50 Hz; 250W; 2A fuse
Dimensions	190 x 300 x 95 mm (7.5 x 11.8 x 3.7")
Weight	4.8 Kg (10.6 lb.)

ORDERING INFORMATION

HI 839800-01 (115 Vac) and **HI 839800-02** (230 Vac) are supplied with instructions.

ACCESSORIES

- HI 740216** Test tube cooling rack (25 tube capacity)
- HI 740217** Laboratory bench safety shield
- HI 151-00** Electronic thermometer for reactor (°C)
- HI 151-01** Electronic thermometer for reactor (°F)



HI 740217 Lab Safety Shield

HI 83200

Multiparameter Photometer

Measure up to 36 Parameters





Built for Labs, Flexible for Field Use

HI 83200 is one of the most versatile photometers on the market. Just one meter measures up to 36 of the most important water quality parameters.

HI 83200, like other instruments in this series, runs for hours on common 9V batteries. In addition, it can operate continuously with input voltage of 12-20 Vdc.

HI 83200 is extremely simple to use. The front mask lists all the parameters in numerical order and the display shows the same numbers for a quick reference during testing.

The meter can be zeroed in seconds and the reagents cost much less than what you have been paying. All this and much more at a fraction of the cost of expensive and complex spectrophotometers!

HANNA photometers use an exclusive positive-locking system to ensure that the cuvet is in the same position every time it is placed into the measurement cell.

A built-in RS232 port ensures that data can be downloaded to your PC for further study. Use our optional HI 92000 Windows® compatible software to get the most out of your meter.

- *PC compatible*
- *User friendly prompts and auto-diagnostic messages on LCD*

Test	Range	Method	Reagent Code
Aluminum	0.00 to 1.00 mg/L	Aluminon	HI 93712-01
Ammonia MR	0.00 to 10.00 mg/L	Nessler	HI 93715-01
Ammonia LR	0.00 to 3.00 mg/L	Nessler	HI 93700-01
Bromine	0.00 to 8.00 mg/L	DPD	HI 93716-01
Chlorine Dioxide	0.00 to 2.00 mg/L	Chlorophenol Red	HI 93738-01
Chlorine*, Free	0.00 to 2.50 mg/L	DPD	HI 93701-01
Chlorine*, Total	0.00 to 3.50 mg/L	DPD	HI 93711-01
Chromium VI HR	0 to 1000 µg/L	Diphenylcarbohydrazide	HI 93723-01
Chromium VI LR	0 to 300 µg/L	Diphenylcarbohydrazide	HI 93749-01
Color	0 to 500 PCU	Platinum Cobalt	—
Copper HR	0.00 to 5.00 mg/L	Bicinchoninate	HI 93702-01
Copper LR	0 to 1000 µg/L	Bicinchoninate	HI 95747-01
Cyanide	0.000 to 0.200 mg/L	Pyridine-Pyrazalone	HI 93714-01
Cyanuric Acid	0 to 80 mg/L	Turbidimetric	HI 93722-01
Fluoride	0.00 to 2.00 mg/L	SPADNS	HI 93729-01
Hardness (calcium)	0.00 to 2.70 mg/L	Calmagite	HI 93720-01
Hardness (magnesium)	0.00 to 2.00 mg/L	EDTA	HI 93719-01
Hydrazine	0 to 400 µg/L	p-Dimethylaminobenzaldehyde	HI 93704-01
Iodine	0.0 to 12.5 mg/L	DPD	HI 93718-01
Iron HR	0.00 to 5.00 mg/L	Phenantroline	HI 93721-01
Iron LR	0 to 400 µg/L	TPTZ	HI 93746-01**
Manganese HR	0.0 to 20.0 mg/L	Periodate	HI 93709-01
Manganese LR	0 to 300 µg/L	PAN	HI 93748-01**
Molybdenum	0.0 to 40.0 mg/L	Mercaptoacetic Acid	HI 93730-01
Nickel HR	0.00 to 7.00 g/L	Photometric	HI 93726-01
Nitrate	0.0 to 30.0 mg/L	Cadmium Reduction	HI 93728-01
Nitrite HR	0 to 150 mg/L	Ferrous Sulphate	HI 93708-01
Nitrite LR	0.00 to 0.35 mg/L	Diazotization	HI 93707-01
Oxygen, Dissolved (D.O.)	0.0 to 10.0 mg/L	Winkler	HI 93732-01
pH	6.5 to 8.5 pH	Phenol Red	HI 93710-01
Phosphate HR	0.0 to 30.0 mg/L	Amino Acid	HI 93717-01
Phosphate LR	0.00 to 2.50 mg/L	Ascorbic Acid	HI 93713-01
Phosphorus	0.0 to 15.0 mg/L	Amino Acid	HI 93706-01
Silica	0.00 to 2.00 mg/L	Heteropoly blue	HI 93705-01
Silver	0.000 to 1.000 mg/L	PAN	HI 93737-01**
Zinc	0.00 to 3.00 mg/L	Zincon	HI 93731-01

SPECIFICATIONS	HI 83200
Light Source	4 tungsten lamps with narrow band interference filters at 420/525/575/610 nm
Light Detector	4 Silicon Photocells
Power Supply	(2) 9V battery or 12 Vdc adapter
Auto-off	after 10 minutes of non-use
Environment	0 to 50°C (32 to 122°F); RH max 95% non-condensing
Dimensions	230x165x70 mm (9x6.5x2.8")
Weight	640 g (22.6 oz.)

ORDERING INFORMATION

HI 83200-01 (115 Vac) and **HI 83200-02** (230 Vac) are supplied with cuvetts (3), bottle for DO test, batteries, 12 Vdc adapter and instruction manual.

* For Chlorine, liquid reagents are available..

** Reagents for 50 tests

All reagents with -01 final code are for 100 tests.



Multiparameter Photometers

HANNA's Professional Multiparameter Photometers

HI 83203*



HI 83203 Test

Ammonia LR	Nitrite HR
Ammonia MR	Nitrite LR
Chlorine, Free	Oxygen, Dissolved (DO)
Chlorine, Total	pH
Copper HR	Phosphate HR
Copper LR	Phosphate LR
Nitrate	

HI 83209*



HI 83209 Test

Ammonia LR	Nitrite HR
Ammonia MR	Nitrite LR
Chlorine, Free	Oxygen, Dissolved (DO)
Chlorine, Total	pH
Chromium VI HR	Phosphate HR
Chromium VI LR	Phosphate LR
Color	Phosphorus
Copper HR	Silica
Copper LR	Silver
Nitrate	Zinc

HI 83211*



HI 83211 Test

Aluminum	Molybdenum
Ammonia LR	Nickel HR
Ammonia MR	Nickel LR
Chromium VI HR	pH
Chromium VI LR	Phosphate HR
Copper HR	Phosphate LR
Copper LR	Phosphorus
Cyanuric Acid	Silica
Iodine	Silver
Iron HR	Zinc
Iron LR	

HI 83218*



HI 83218 Test

Ammonia HR	Chromium VI LR	Nitrate	Nitrite LR
Ammonia MR	Cyanide	Nitrite HR	Phosphorus
Chromium VI HR			

HI 83225* • HI 83215*



HI 83225 Test

Ammonia LR	Nitrate LR	Phosphorus LR	Potassium LR	Calcium
Ammonia MR	Nitrate MR	Phosphorus MR	Potassium MR	Magnesium
Ammonia HR	Nitrate HR	Phosphorus HR	Potassium HR	Sulfate

HI 83215 Test

Ammonia LR	Nitrate LR	Phosphorus LR	Potassium LR
Ammonia MR	Nitrate MR	Phosphorus MR	Potassium MR
Ammonia HR	Nitrate HR	Phosphorus HR	Potassium HR

* Supplied with 115V (add -1) or (add -2) 230V power supply

Multiparameter Photometers

HANNA's Professional Multiparameter Photometers

HI 83206*



HI 83206 Test	
Ammonia LR	Nickel LR
Ammonia MR	Nitrate
Chlorine, Free	Nitrite HR
Chlorine, Total	Nitrite LR
Chromium VI HR	Oxygen, Dissolved (DO)
Chromium VI LR	pH
Color	Phosphate HR
Copper HR	Phosphate LR
Copper LR	Phosphorus
Cyanuric Acid	Silica
Molybdenum	Silver
Nickel HR	Zinc

HI 83213*



HI 83213 Test	
Aluminum	Nickel HR
Ammonia LR	Nickel LR
Ammonia MR	Nitrate
Bromine	Nitrite HR
Chlorine, Free	Nitrite LR
Chlorine, Total	Oxygen, Dissolved (DO)
Chromium VI HR	pH
Chromium VI LR	Phosphate HR
Color	Phosphate LR
Copper HR	Phosphorus
Copper LR	Silver
Iodine	Zinc

HI 83205*



HI 83205 Test	
Aluminum	Iron HR
Ammonia LR	Iron LR
Ammonia MR	Molybdenum
Bromine	Nitrate
Chlorine Dioxide	Nitrite HR
Chlorine, Free	Nitrite LR
Chlorine, Total	Oxygen, Dissolved (DO)
Chromium VI HR	pH
Chromium VI LR	Phosphate HR
Copper HR	Phosphate LR
Copper LR	Silica
Hydrazine	Zinc

HI 83212*

HI 83212 Test	
Ammonia LR	Molybdenum
Ammonia MR	Phosphate HR
Chlorine, Free	Phosphate LR
Chlorine, Total	Phosphorus
Copper HR	Silica
Copper LR	Silver
Hydrazine	



HI 83210*



HI 83210 Test	
Aluminum	pH
Chlorine Dioxide	Phosphate HR
Chlorine, Free	Phosphate LR
Chlorine, Total	Silver
Color	Silica
Dissolved Oxygen (D.O.)	Zinc

HI 83208*



Test	
Ammonia MR	Nickel HR
Ammonia LR	Nickel LR
Chlorine, Free	Nitrate
Chlorine, Total	Oxygen, Dissolved (DO)
Copper HR	pH
Copper LR	Phosphate HR
Fluoride	Phosphate LR
Iron HR	Phosphorus
Iron LR	Silver
Manganese HR	Silica
Manganese LR	Zinc
Molybdenum	

HI 83216* • HI 83226*



HI 83226 Test	
Alkalinity	Cyanuric Acid
Bromine	Hardness (Calcium)
Chlorine, Free	Iron
Chlorine, Total	Ozone
Copper, Free	pH
Copper, Total	

HI 83216 Test	
Alkalinity	Cyanuric Acid
Chlorine, Free	Hardness (Calcium)
Chlorine, Total	pH

HI 83207*



HI 83207 Test	
Aluminum	Nickel HR
Chlorine, Free	Nickel LR
Chlorine, Total	Nitrate
Color	Oxygen, Dissolved (DO)
Copper HR	pH
Copper LR	Phosphate HR
Fluoride	Phosphate LR
Manganese HR	Phosphorus
Manganese LR	Silver
Molybdenum	Zinc

* Supplied with 115V (add -1) or (add -2) 230V power supply



Multiparameter Photometers

HANNA's Professional Multiparameter Photometers



HI 93752 Test
Calcium
Magnesium HR

HI 93710 Test
Free and Total Chlorine
pH

HI 93724 Test
Cyanuric Acid
pH

HI 93725 Test
pH
Total Hardness

HI 93741 Test
Iron
Total Hardness

HI 93742 Test
Iron
Manganese LR

HI 93743 Test
Iron LR
pH

HI 93101 Test
Bromine
Chlorine
Cyanuric Acid
Iron
Iodine
pH

HI 93744 Test
Total Hardness
Iron LR
pH

HI 93103 Test
Chlorine
CYS
pH

HI 93745 Test
Free and Total Chlorine
Total Hardness
Iron
pH

HI 93 Series

Single Parameter Photometers

HANNA's Professional Multiparameter Photometers



SPECIFICATIONS				
Description	Code	Range	Increment	Method
Aluminum	HI 93712	0.00 to 1.00 mg/L	0.01 mg/L	Aluminon
Ammonia, HR	HI 93733	0.0 to 50.0 mg/L	0.1 mg/L	Nessler
Ammonia, MR	HI 93715	0.00 to 9.99 mg/L	0.01 mg/L	Nessler
Ammonia, LR	HI 93700	0.00 to 3.00 mg/L	0.01 mg/L	Nessler
Bromine	HI 93716	0.00 to 8.00 mg/L	0.01 mg/L	DPD
Chloride	HI 93753	0.0 to 20.0 mg/L	0.01 mg/L	Mercury (II) thiocyanate
Chlorine, Free	HI 93701	0.00 to 2.50 mg/L	0.01 mg/L	DPD
Chlorine, Free and Total	HI 93734	0.0 to 10.0 mg/L	0.1 mg/L	DPD
Chlorine, Free and Total	HI 93711	0.00 to 2.50(f) /3.50(t)mg/L	0.01 mg/L	DPD
Chlorine Dioxide	HI 93738	0.00 to 2.00 mg/L	0.01 mg/L	Chlorophenol Red
Chromium VI, HR	HI 93723	0 to 1000 µg/L	1 µg/L	Diphenylcarbohydrazide
Chromium VI, LR	HI 93749	0 to 300 µg/L	1 µg/L	Diphenylcarbohydrazide
Color	HI 93727	0 to 500 PCU	10 PCU	Chloroplatinate
Copper, HR	HI 93702	0.00 to 5.00 mg/L	0.01 mg/L	Bicinchoninate
Cyanide	HI 93714	0.000 to 0.200 mg/L	0.001 mg/L	Pyridine-Pyrazalone
Cyanuric Acid	HI 93722	0 to 80 mg/L	1 mg/L	Turbidimetric
Fluoride, HR	HI 93739	0.0 to 20.0 mg/L	0.1 mg/L	SPADNS
Fluoride, LR	HI 93729	0.00 to 2.00 mg/L	0.01 mg/L	SPADNS
Hardness, Ca	HI 93720	0.00 to 2.70 mg/L	0.01 mg/L	Calmagite
Hardness, Mg	HI 93719	0.00 to 2.00 mg/L	0.01 mg/L	Colorimetric
Hardness, Total	HI 93735	0 to 750 mg/L	1 / 5 mg/L	EPA 130.1
Hydrazine	HI 93704	0 to 400 µg/L	1 µg/L	p-Dimethylaminobenzaldehyde
Iodine	HI 93718	0.0 to 12.5 mg/L	0.1 mg/L	DPD
Iron, HR	HI 93721	0.00 to 5.00 mg/L	0.01 mg/L	Phenantroline
Iron, LR	HI 93746	0 to 400 µg/L	1 µg/L	TPTZ
Manganese, HR	HI 93709	0.0 to 20.0 mg/L	0.1 mg/L	Periodate Oxidation
Manganese, LR	HI 93748	0 to 300 µg/L	1 µg/L	PAN
Molybdenum	HI 93730	0.0 to 40.0 mg/L	0.1 mg/L	Mercaptoacetic Acid
Nickel HR	HI 93726	0.00 to 7.00 g/L	0.01 g/L	Photometric
Nickel LR	HI 93740	0.000 to 1.000 mg/L	0.001 mg/L	PAN
Nitrate	HI 93728	0.0 to 30.0 mg/L	0.1 mg/L	Cadmium Reduction
Nitrate	HI 93828	0 to 100 mg/L	1 mg/L	Cadmium Reduction
Nitrite, HR	HI 93708	0 to 150 mg/L	1 mg/L	Ferrous Sulfate
Nitrite, LR	HI 93707	0.00 to 0.35 mg/L	0.01 mg/L	Diazotation
Oxygen, Dissolved (DO)	HI 93732N	0.0 to 10.0 mg/L	0.1 mg/L	Modified Winkler
Phosphate, HR	HI 93717	0.0 to 30.0 mg/L	0.1 mg/L	Amino Acid
Phosphate, LR	HI 93713	0.00 to 2.50 mg/L	0.01 mg/L	Ascorbic Acid
Phosphorus	HI 93706	0.0 to 15.0 mg/L	0.1 mg/L	Amino Acid
Potassium	HI 93750	0.00 to 50.0 mg/L	0.05/0.1 mg/L	Turbidimetric
Silica	HI 93705	0.00 to 2.00 mg/L	0.01 mg/L	Heteropoly Blue
Silver	HI 93737	0.000 to 1.000 mg/L	0.001 mg/L	PAN
Sulfate	HI 93751	0 to 150 mg/L	1 mg/L	Turbidimetric
Zinc	HI 93731	0.00 to 3.00 mg/L	0.01 mg/L	Zincon



the Guesswork Out of Laboratory and Field Measurements

HANNA photometers are dedicated to a specific ion and utilize a state-of-the-art custom microprocessor with a diode photocell for detection. The readings are shown in large digits on a clear LCD.

- **Quick & Simple-to-Use**

Just zero your sample, dissolve a readily soluble powder or add a few drops of a reagent in the cuvet and take a reading.

- **Lightweight & Portable**

These portable meters are ideal for spot-checks in or outside the lab!

- **Long Battery Life**

These meters have a battery life lasting a minimum of 300 tests and an auto shut-off feature. The display gives a low battery warning and a few extra measurements before new batteries are necessary.

- **Tests Made Inexpensive**

A wide selection of inexpensive reagents for 100 or 300 tests further reduces the cost-per-test. These meters will in fact cost less than the several test kits needed to cover the same range.

HI 96711

Free/Total Chlorine Photometer

with T.I.S. — Tag Identification System Technology



FastTracker[™]
A new revolution in organized data management.

The HANNA **Fast Tracker**[™]
system is a new revolution
in simple and organized data management.

Fast Tracker[™] Tag Identification System (T.I.S.)

HANNA'S exclusive Fast Tracker[™] — Tag Identification System simplifies test logging while retaining the management versatility needed to search, filter and export data. The system, designed for scientific and industrial applications, helps verify that samples have truly been taken at pre-established locations during safety audits and inspections.

The Fast Tracker[™] system is easy to install and operate. Just place the iButton[®] tags near your sampling sites that need to be regularly checked. This meter identifies and authenticates logged data by storing the iButton[®] serial number, time and date stamp by simply touching the iButton[®] with the matching connector on the instrument. The number of tags that can be installed is unlimited and each tag has a unique identification code.

With our HI 92000 Windows[®] compatible application software, users can sort or filter all collected test data using different criteria such as specific sampling location, parameter, date and time intervals or fixed range to filter measured values. The data can be plotted in a graph, exported to other common Windows[®] applications or printed for reporting purposes.

Photometers Loaded with HANNA Innovations

The HANNA HI 96711 is an auto-diagnostic, microprocessor-based, portable photometer that benefits from HANNA years of experience as manufacturer of analytical instruments.

HI 96711 measures free & total chlorine and features quick traceability of each measured sample.

The advanced optical system is based on a tungsten lamp and a narrow-band interference filter that allows highly accurate and repeatable readings.

As a result of the iButton[®] technology, this meter can associate a time and location label to every record. The iButton[®] is mounted on the top of the meter and you have to just touch the tag that identifies the sample location before performing each measurement.

The meter can log up to 99 measurements in the internal memory and all stored data can be downloaded to a PC through the RS232 serial port and the HI 92000 software.

The sample traceability system allows users to collect and manage data in a very simple and error free way. All measurements can be quickly organized by time or by sample. The check function allows the user to validate the good performance of the instrument at any time.

- CAL CHECK[™] validation
- Exclusive Tag Identification System (Fast Tracker[™])
- Logging of up to 99 records
- Supplied as a kit
- PC compatibility



HI 96711

Free/Total Chlorine Photometer

with T.I.S. — Tag Identification System Technology



“C” Version Supplied as a kit

It's easy to add new tags later on to increase an already existing database.



Peace of mind.

CAL CHECK™ Calibration Validation

With HANNA's exclusive CAL CHECK™ validation function users are able to verify the performance of the instrument at any time. Taking just a few short steps, the validation procedure is user friendly and ensures that the meter is properly calibrated.

iButton® Tags are Easy to Install



Install TAGs near your sampling points for quick and easy iButton® readings. Each TAG contains a computer chip with a unique identification code encased in stainless steel. You can install a practically unlimited amount of TAGs. Additional TAGs can be ordered for all of your traceability requirements.

Specifications		HI 96711
Range	Free Chlorine	0.00 to 5.00 mg/L
	Total Chlorine	0.00 to 5.00 mg/L
Resolution		0.01 mg/L 0.00 to 3.50 mg/L; 0.10 mg/L above 3.50 mg/L
Precision		±0.02 mg/L to 1.00 mg/L
Light Source		Tungsten lamp with narrow band interference filter 525 nm
Light Detector		Silicon Photocell
Power Supply		(1) 9V battery
Auto-off		After 10 min of non-use in measuring mode After 1 hour of non-use in calibration mode
Environment		0 to 50°C (32 to 122°F); RH max 95% non-condensing
Data-Logging		99 records
Serial Interface		RS232 with 9600 baud rate
Dimensions		216 x 83 x 65 mm (8.5 x 3.3 x 2.5")
Weight		420 g (17 oz.)
Method		Adaptation of USEPA 330.5 Method and Standard Methods 4500-Cl G

ORDERING INFORMATION

HI 96711 is supplied with (2) sample cuvetts with caps, (10) reagent powder packets, (4) batteries and instruction manual.

HI 96711C is supplied with (2) sample cuvetts with caps, (3) CAL CHECK™ cuvetts, (10) reagent powder packets, cuvet cleaning cloth, (5) iButton® tags, (4) batteries, scissors and instruction manual in a hard carrying case.

REAGENTS

HI 93701-01 Reagents for 100 tests (Free Chlorine)

HI 93701-03 Reagents for 300 tests (Free Chlorine)

HI 93711-01 Reagents for 100 tests (Total Chlorine)

HI 93711-03 Reagents for 300 tests (Total Chlorine)

HI 95701-11 CAL CHECK™ standard cuvetts for Free Chlorine

HI 95711-11 CAL CHECK™ standard cuvetts for Total Chlorine

SOLUTIONS

HI 93703-50 Cuvet cleaning solution, 250 mL

ACCESSORIES

HI 920005 iButton® TAGs (5)

HI 92000 Software for PC connection, Windows® compatible

HI 920011 Serial cable for PC connection

HI 731318 Cuvet cleaning cloth (4)

HI 731331 Measuring cuvetts (4)

HI 731335 Cuvet caps (4)

HI 96 series

Water Resistant Single Parameter Photometers

with HANNA's Exclusive CAL CHECK™



Peace of mind.

When performing measurements you need to know that the instrument you are using is right on. With HANNA's exclusive CAL CHECK™ feature you can now rest assured. Simply insert the factory calibrated standard of a known concentration and verify that your instrument is accurate.

Photometers Designed for Laboratory Benchtops and Handheld Field Use

HANNA's new line of single parameter photometers includes instruments to measure ammonia, chlorine at several ranges, copper, anionic detergents, fluoride, iron, nitrite, phosphate, phosphorus and more. This series features water resistance, a large dual-level LCD, an advanced optical system and HANNA's exclusive CAL CHECK™ validation function. The advanced optical system is based on a special tungsten lamp (model HI 96715 features an LED) and a narrow band interference filter assuring accurate readings every time.

With the exclusive CAL CHECK™ validation function users are able to verify the performance of the instrument at any time. Taking just a few short steps, the validation procedure is extremely user friendly and ensures that the meter is properly calibrated. Just use the exclusive HANNA ready-made, NIST traceable

standards to verify the performance of the instrument and recalibrate if necessary. All instruments are factory calibrated and the electronic and optical design minimizes the need for frequent calibration.

Ideal for field applications, these meters are water resistant and the lamp and filter measuring system is protected from dust or dirt by a transparent cup. Display codes aid the user in routine operations and include a low battery warning. An auto shut-off feature turns the instruments off after 10 minutes of non-use.

The cuvet is made from special optical glass to obtain best results and an exclusive positive-locking system ensures that the cuvet is in the same position every time it is placed into the measurement cell. The cell is designed to fit a wide mouth cuvet making it easier to add both samples and reagents.

The reagents are in powder or liquid form and the amount of reagent is precisely dosed to ensure maximum repeatability.

- Large, dual-level LCD
- Water-resistant
- Accuracy verification
- User calibration
- Certified calibration & verification standards
- EPA compliant
- Custom ranges
- Long battery life
- Order the "C" version for a complete kit

READ/TIMER function

Counts down to appropriate time interval before a reading is displayed. This feature ensures consistency in measurements across multiple users.

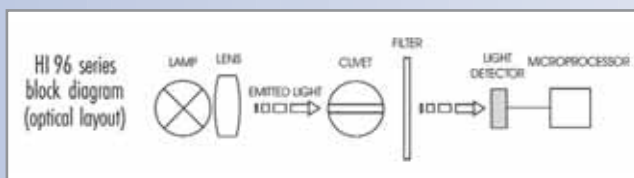

Calibration Date on Display

The HI 96 series of photometers display the last time calibration was performed so you may schedule routine calibrations—ideal for ISO and Good Laboratory Practice environments.

Water Resistant Single Parameter Photometers

with HANNA's Exclusive CAL CHECK™

SPECIFICATIONS					
Parameter	Code*	Range	Precision	Narrow Band Filter	Method
Ammonia, Medium Range	HI 96715	0.00 to 9.99 mg/L (as NH ₃ -N)	±0.12 mg/L @ 6.00 mg/L	@ 466 nm	Adaptation of the ASTM Manual of Water and Environmental Technology, D1426-93, Nessler Method.
Chlorine, Ultra High Range	HI 96771	UHR: 0 to 500 mg/L LR: 0.00 to 5.00 mg/L	±2 mg/L @ 100 mg/L ±0.02 mg/L @ 1.00 mg/L	@ 525 nm	Adaptation of Standard Methods, 20th edition, 4500-Cl.
Chlorine, Free	HI 96701	0.00 to 5.00 mg/L	±0.02 mg/L @ 1.00 mg/L	@ 525 nm	Adaptation of the USEPA method 330.5 and Standard Method 4500-Cl G.
Chlorine, Free for Drinking Water Applications	HI 96762	0.000 to 0.500 mg/L	±0.004 mg/L @ 0.200 mg/L	@ 525 nm	Adaptation of Standard Methods, 20th edition, 4500-Cl G.
Chlorine, Free and Total	HI 96781	Free Cl ₂ : 0.00 to 5.00 mg/L; Total Cl ₂ : 0.00 to 5.00 mg/L	±0.02 mg/L @ 1.00 mg/L	@ 525 nm	Adaptation of the USEPA method 330.5 and Standard Method 4500-Cl G.
Chlorine, Free and Total	HI 96724	Free Cl ₂ : 0.00 to 5.00 mg/L; Total Cl ₂ : 0.00 to 5.00 mg/L	±0.03 mg/L @ 1.00 mg/L	@ 525 nm	Adaptation of the USEPA method 330.5 and Standard Method 4500-Cl G.
Chlorine, Free and Total, High Range	HI 96734	Free Cl ₂ : 0.00 to 10.00 mg/L; Total Cl ₂ : 0.00 to 10.00 mg/L	±0.06 mg/L @ 3.00 mg/L	@ 525 nm	Adaptation of the USEPA method 330.5 and Standard Method 4500-Cl G.
Chlorine, Total for the Analysis of Trace Total Chlorine Concentration	HI 96761	0.000 to 0.500 mg/L	±0.004 mg/L @ 0.200 mg/L	@ 525 nm	Adaptation of Standard Methods, 20th edition, 4500-Cl G.
Copper, Low Range	HI 96747	0.000 to 1.500 mg/L	±0.015 mg/L @ 0.750 mg/L	@ 560 nm	Adaptation of the USEPA approved bicinchoninate method.
Detergents, Anionic	HI 96769	0.00 to 3.50 mg/L (as SDBS)	±0.04 mg/L @ 1.00 mg/L	@ 610 nm	Adaptation of the USEPA method 425.1 for drinking waters, surface waters, domestic and industrial wastes and Standard Methods, 20th edition, 5540C, Anionic Surfactants as MBAS.
Fluoride, Low Range	HI 96729	0.00 to 2.00 mg/L	±0.03 mg/L @ 1.00 mg/L	@ 575 nm	Adaptation of the EPA method 340.1 and SPADNS method.
Iron, High Range	HI 96721	0.00 to 5.00 mg/L	±0.01 mg/L @ 1.50 mg/L	@ 525 nm	Adaptation of the USEPA method 315B and Standard Method 3500-Fe B.
Nitrite, Low Range	HI 96707	0.000 to 0.600 mg/L (as NO ₂ ⁻ -N)	±0.001 mg/L @ 0.100 mg/L	@ 525 nm	Adaptation of an EPA approved method.
Phosphate, High Range	HI 96717	0.0 to 30.0 mg/L	±0.5 mg/L @ 12 mg/L	@ 525 nm	Amino Acid Method, adapted from Standard Method for the Examination of Water and Wastewater.
Phosphorus	HI 96706	0.0 to 15.0 mg/L	±0.2 mg/L @ 6.0 mg/L	@ 525 nm	Amino Acid Method, adapted from Standard Method for the Examination of Water and Wastewater.
Silica	HI 96770	0 to 200 mg/L (as SiO ₂)	±5 mg/L @ 100 mg/L	@ 466 nm	Adaptation of the USEPA method 370.1 for drinking, surface and saline waters, domestic and industrial wastes and Standard Method 4500-SiO ₂ C.

SPECIFICATIONS common to all models	
Light Source	Tungsten lamp; LED (HI 96715 and HI 96770 only)
Environment	0 to 50°C (32 to 122°F); Max 95% RH non-condensing
Battery Type/Life	(1) 9V/approx. 200 hours continuous use
Auto Shut-off	After 10 minutes of non-use in measurement mode
Dimensions/Weight	192 x 102 x 67 mm (7.6 x 4 x 2.6")/290 g (10 oz.)

ORDERING INFORMATION

HI 96 series of photometers are supplied with sample cuvetts with caps, 9V battery and instruction manual.

HI 96 "C" series of photometers is supplied with CAL CHECK™ standard cuvetts, sample cuvetts with caps, 9V battery, cuvet cleaning cloth and instruction manual in a hard carrying case (additional accessories such as glass vials, pipettes and scissors are included when applicable).



Available as a KIT

Includes CAL CHECK™ standard cuvetts, cuvet cleaning cloth and scissors (when applicable) bundled in a deluxe hardshell carrying case.

Just add a "C" at the end of the part #. Eg: HI 96715C



HI 95 Series Available

Standard Reagents

for Single and Multiparameter Photometers

Test	Reagent Kit	No. of Tests
Alkalinity	HI 93755-01	100
	HI 93755-03	300
Aluminum	HI 93712-01	100
	HI 93712-03	300
Ammonia HR	HI 93764B-25	25
	HI 93733-01	100
	HI 93733-03	300
Ammonia MR	HI 93715-0	100
	HI 93715-03	300
Ammonia LR	HI 93700-01	100
	HI 93700-03	300
	HI 93764A-25	25
Bromine	HI 93716-01	100
	HI 93716-03	300
Calcium and Magnesium	HI 93752-01	100
	HI 93752-03	100
Chloride	HI 93753-01	100
	HI 93753-03	300
Chlorine Dioxide	HI 93738-01	100
	HI 93738-03	300
Chlorine UHR	HI 95771-01	100
	HI 95771-03	300
Chlorine, Free	HI 93701-01	100
	HI 93701-03	300
	HI 93701-F	300
Chlorine, Free and Total HR	HI 93734-01	100
	HI 93734-03	300
Chlorine, Free ULR	HI 95762-01	100
	HI 95762-03	300
Chlorine, Total	HI 93711-01	100
	HI 93711-03	300
	HI 93701-T	300
Chlorine, Total ULR	HI 95761-01	100
	HI 95761-03	300
Chromium VI HR	HI 93723-01	100
	HI 93723-03	300
Chromium VI LR	HI 93749-01	100
	HI 93749-03	300
COD, HR	HI 93754C-25	25
COD, LR EPA*	HI 93754A-25	25
COD, LR ISO**	HI 93754F-25	25
COD, LR Mercury Free***	HI 93754D-25	25
COD, MR EPA*	HI 93754B-25	25
COD, MR ISO**	HI 93754G-25	25
COD, MR Mercury Free***	HI 93754E-25	25
Copper HR	HI 93702-01	100
	HI 93702-03	300
	total HI 93702T-01	100
	total HI 93702T-03	300
Copper LR	HI 95747-01	100
	HI 95747-03	300
Cyanide	HI 93714-01	100
	HI 93714-03	300
Cyanuric Acid	HI 93722-01	100
	HI 93722-03	300
Detergents, Anionic	HI 95769-01	40
Fluoride HR	HI 93739-01	100
	HI 93739-03	300
Fluoride LR	HI 93729-01	100
	HI 93729-03	300
Hardness (Calcium)	HI 93720-01	100
	HI 93720-03	300

** The chromium-sulfuric acid method is officially recognized by EPA for wastewater test

* HI 93754F-25 and HI 93754G-25 method is according to ISO 15705 method

*** It is a recommended method for generic test and for samples without chloride

Test	Reagent Kit	No. of Tests
Hardness (Magnesium) and Total Hardness	HI 93719-01	100
	HI 93719-03	300
Hardness, Total HR	HI 93735-02	100
Hardness, Total LR	HI 93735-00	100
Hardness, Total LR+MR+HR	HI 93735-0	100
Hardness, Total MR	HI 93735-01	100
Hydrazine	HI 93704-01	100
	HI 93704-03	300
Iodine	HI 93718-01	100
	HI 93718-03	300
Iron HR	HI 93721-01	100
	HI 93721-03	300
Iron LR	HI 93746-01	50
	HI 93746-03	150
Manganese HR	HI 93709-01	100
	HI 93709-03	300
Manganese LR	HI 93748-01	50
	HI 93748-03	150
Molybdenum	HI 93730-01	100
	HI 93730-03	300
Nickel HR	HI 93726-01	100
	HI 93726-03	300
Nickel LR	HI 93740-01	50
	HI 93740-03	150
Nitrate	HI 93728-01	100
	HI 93728-03	300
Nitrite HR	HI 93766-50	50
	HI 93708-01	100
	HI 93708-03	300
Nitrite LR	HI 93707-01	100
	HI 93707-03	300
Nitrogen, Total HR	HI 93767B-50	50
Nitrogen, Total LR	HI 93767A-50	50
Oxygen, Dissolved (D.O.)	HI 93732-01	100
	HI 93732-03	300
Ozone	HI 93757-01	100
	HI 93757-03	300
pH	HI 93710-01	100
	HI 93710-03	300
Phosphate HR	HI 93717-01	100
	HI 93717-03	300
Phosphate LR	HI 93713-01	100
	HI 93713-03	300
Phosphorus	HI 93706-01	100
	HI 93706-03	300
Phosphorus, Acid and Hydrolyzable	HI 93758B-50	50
Phosphorus Reactive HR	HI 93763A-50	50
Phosphorus Reactive LR	HI 93758A-50	50
Phosphorus Total HR	HI 93763B-50	50
Phosphorus Total LR	HI 93758C-50	50
Potassium	HI 93750-01	100
	HI 93750-03	300
Silica	HI 93705-01	100
	HI 93705-03	300
Silver	HI 93737-01	50
	HI 93737-03	150
Sulphate	HI 93751-01	100
	HI 93751-03	300
Zinc	HI 93731-01	100
	HI 93731-03	300

CAL CHECK™ Standard Reagents

for HI 96 and HI 95 Series Photometers



HI 96 Series



HI 96711



HI 95 Series

HI 96701 • HI 95701

- HI 93701-01** Powder reagents for 100 tests (Free Chlorine)
- HI 93701-03** Powder reagents for 300 tests (Free Chlorine)
- HI 95701-11** CAL CHECK™ standard cuvetts

HI 96762 • HI 95762

- HI 95762-01** Powder reagents for 100 tests (Free Chlorine)
- HI 95762-03** Powder reagents for 300 tests (Free Chlorine)
- HI 95762-11** CAL CHECK™ standard cuvetts

HI 96761 • HI 95761

- HI 95761-01** Powder reagents for 100 tests (total chlorine)
- HI 95761-03** Powder reagents for 300 tests (total chlorine)
- HI 95761-11** CAL CHECK™ standard cuvetts

HI 96711 • HI 96781 • HI 95711

- HI 93701-01** Powder reagents for 100 tests (Free Chlorine)
- HI 93701-03** Powder reagents for 300 tests (Free Chlorine)
- HI 93711-01** Powder reagents for 100 tests (Total Chlorine)
- HI 93711-03** Powder reagents for 300 tests (Total Chlorine)
- HI 95701-11** CAL CHECK™ standard cuvetts for Free Chlorine
- HI 95711-11** CAL CHECK™ standard cuvetts for Total Chlorine

HI 96724 • HI 95724

- HI 93701-T** Liquid reagents for 300 tests of Total Chlorine
- HI 93701-F** Liquid reagents for 300 tests of Free Chlorine
- HI 93711-D3** DPD3 reagent for 200 tests of Total Chlorine
- HI 95724-11** CAL CHECK™ standard cuvetts

HI 95734

- HI 93734-01** Powder reagents for 100 tests (Free or Total Chlorine)
- HI 93734-03** Powder reagents for 300 tests (Free or Total Chlorine)
- HI 95734-11** CAL CHECK™ standard cuvetts

HI 96771 • HI 95771

- HI 95771-01** Powder reagents for 100 tests
- HI 95771-03** Powder reagents for 300 tests
- HI 95771-11** CAL CHECK™ standard cuvetts

HI 96747 • HI 95747

- HI 95747-01** Reagents for 100 tests
- HI 95747-03** Reagents for 300 tests
- HI 95747-11** CAL CHECK™ standard cuvetts

HI 96769 • HI 95769

- HI 95769-01** Reagent kit for 40 tests
- HI 95769-11** CAL CHECK™ standard cuvetts

HI 96729 • HI 95729

- HI 93703-53** Reagent for chlorine dropper
- HI 93729-01** Reagents for 100 tests
- HI 93729-03** Reagents for 300 tests
- HI 95729-11** CAL CHECK™ standard cuvetts

HI 96721 • HI 95721

- HI 93721-01** Reagent kit for 100 tests
- HI 93721-03** Reagent kit for 300 tests
- HI 95721-11** CAL CHECK™ standard cuvetts

HI 96715 • HI 95715

- HI 93715-01** Reagents for 100 tests
- HI 93715-03** Reagents for 300 tests
- HI 95715-11** CAL CHECK™ standard

HI 96707 • HI 95707

- HI 93707-01** Reagents for 100 tests
- HI 93707-03** Reagents for 300 tests
- HI 95707-11** CAL CHECK™ standard cuvetts

HI 96706 • HI 95706

- HI 93706-01** Reagents for 100 tests
- HI 93706-03** Reagents for 300 tests
- HI 95706-11** CAL CHECK™ standard cuvetts

HI 96717 • HI 95717

- HI 93717-01** Reagents for 100 tests
- HI 93717-03** Reagents for 300 tests
- HI 95717-11** CAL CHECK™ standard cuvetts

HI 96770

- HI 93717-01** Reagents for 100 tests
- HI 93717-03** Reagents for 300 tests
- HI 95770-11** CAL CHECK™ standard cuvetts

HI 83, 96, 95 and 93 series

Photometer Accessories

SOLUTIONS

- HI 93703-50** Cuvet cleaning solution, 250 mL

ACCESSORIES

- HI 710009** Shockproof rubber boot, blue
- HI 710010** Shockproof rubber boot, orange
- HI 731318** Cuvet cleaning cloth (4)
- HI 731331** Measuring cuvetts (4)
- HI 731335** Cuvet caps (4)



HI 710009 Shockproof Boot



HI 710010 Shockproof Boot



HI 731318 Cuvet Cleaning Cloth



HI 731331 Measuring Cuvets

HI 98811

Printing and Logging Thermistor Thermometer

with Fast Tracker™—Tag Identification System



- Lab-grade precision
- BEPS—Battery Error Prevention System
- Lightweight, rugged housing

FastTracker™
A new revolution in organized data management



Features Fast Tracker™— Tag Identification System

The HANNA portable NTC Fast Tracker™ thermometer with built-in printer enables you to accurately measure and record both temperature and sample identification data. The meter features an easy-to-read LCD with backlight feature for comfortable reading even in dark environments. A user friendly interface provides clear messages regarding errors, functions and more.

The Sample Identification feature eliminates the necessity of manual identification for different measurement results, reducing human errors. An alarm time-out is available to alert the user if more than one year has elapsed since the last calibration and that recalibration may be required.

GLP features guarantee data consistency and provides GLP settings through a password protection method.

HI 98811 has the capability to store the measurements in memory at a user selectable interval from 1 to 180 minutes. This information can be retrieved at a later time and can also be printed.

Each measurement/lot can be uniquely identified by assigning a sample ID code obtained by reading from a Dallas iButton® tag (DS1990A, etc) placed in the field.

HI 98811 also allows the transfer of stored data to a computer via the HI9200/9 infrared transmitter connected to the computer RS232 port.

Each meter can also be uniquely identified by the user by assigning an instrument ID code.

Specifications	HI 98811
Range	-50.0 to 150.0°C; -55.0 to 300.0°F
Resolution	0.1°C (-30.0 to 130°C); 0.2°C (outside); 0.1°F (-18 to 225°F); 0.2°F (225 to 260°F); 0.3°F (outside)
Accuracy	±0.4°C (-20 to 120°C); ±0.7°C (outside); ±0.8°F (-4 to 248°F); 1.3°F (outside) (for 1 year, excluding probe error)
Probe	HI 762BL (included)
Printer	low power impact, 14 characters per line, using 38 mm plain paper (HI 710034)
Printing/Logging Interval	selectable at 1, 2, 5, 10, 15, 30, 60, 120 or 180 minutes
PC Connection	HI 9200 IR interface through RS232 serial port and using HI 92000 software (not included)
Power Supply	(4) 1.5V AA alkaline type/350 hours typical life (with 2700 mA/h batteries, without printing and backlight). 12 VDC adapter (HI 710005 or HI 710006)
Environment	0 to 50°C (32 to 122°F); RH max 95%
Dimensions	220 x 82 x 66 mm (8.7 x 3.2 x 2.6")
Weight	550 g (1.2 lbs.)

ORDERING INFORMATION

HI 98811 is supplied with HI 762BL temperature probe with 1 m cable, paper rolls (5), (4) batteries, rugged carrying case and instructions.

PROBES

HI 762L/10 General purpose/liquid temperature probe with 10 m cable

ACCESSORIES

- HI 920005** iButton® with holder (5)
- HI 710005** 115 Vac/12 Vdc power adapter
- HI 710006** 230 Vac/12 Vdc power adapter
- HI 710034** Paper roll (10)
- HI 710035** Ink cartridge
- HI 9200/9** Serial IR interface for PC connection
- HI 92000** Windows® compatible software
- HI 710031** Rugged carrying case





HI 98810 • HI 98840

Printing and Logging Thermistor Thermometers

Thermometers
Portable Meters

Printing and Logging Thermometers with Log-on-demand

HI 98810 and HI 98840 combine high accuracy and fast response time with an extensive logging feature and an infrared computer transfer system. All stored measurements are correlated with time, date, sample and probe number.

The log-on-demand function is activated by simply pressing one button. While automatic logging, the user can select a time interval from 1 to 180 minutes.

All logged data can be transferred to a PC via HANNA's HI 9200/9 infrared interface cradle connected to the computer serial port. The connection is handled with the HI 92000 Windows® compatible software designed by HANNA.

The large backlit LCD allows readings in dimly lit conditions. These instruments can be powered with batteries or with a 12 Vdc supply.

HI 98810 accepts one temperature probe while HI 98840 can be connected to 4 separate probes at the same time.

HI 98810 is supplied with an HI 762BL temperature probe (for general purpose liquid measurements).

Both models use the HI 762 series of thermistor probes by HANNA.

- *Print an indisputable record of your measurements*
- *Selectable printing and logging intervals*
- *Connect 4 separate probes simultaneously (HI 98840)*
- *Optional computer compatibility with HANNA's HI 92000 compatible Windows® software and HI 9200 infrared interface cradle*



Specifications	HI 98810	HI 98840
Range	-50.0 to 150.0°C; -55.0 to 300.0°F	
Resolution	0.1°C (-30.0 to 130°C); 0.2°C (outside); 0.1°F (-18 to 225°F); 0.2°F (225 to 260°F); 0.3°F (outside)	
Accuracy	±0.4°C (-20 to 120°C); ±0.7°C (outside); ±0.8°F (-4 to 248°F); 1.3°F (outside) (for 1 year, excluding probe error)	
Channels	1	4
Probe	HI 762BL (included)	HI 762 series (not included)
Printer	low power impact, 14 characters per line, using 38 mm plain paper (HI 710034)	
Printing/Logging Interval	selectable at 1, 2, 5, 10, 15, 30, 60, 120 or 180 minutes	
PC Connection	HI 9200 interface through RS232 serial port and using HI 92000 software (not included)	
Power Supply	(4) 1.5V AA battery / approx. 350 hours (without printing and backlight); auto-off selectable after 5, 10, 15, 30, 45 or 60 minutes of non-use; or 12 Vdc input	
Environment	0 to 50°C (32 to 122°F); RH max 95%	
Dimensions	220 x 82 x 66 mm (8.7 x 3.2 x 2.6")	
Weight	550 g (1.2 lbs.)	

ORDERING INFORMATION

HI 98810 and **HI 98840** are supplied with HI762BL temperature probe (one channel version only), batteries (4), instruction manual, paper rolls (5) and rugged carrying case.

PROBES

- HI 762BL** General purpose/liquid temperature probe with 1 m cable
- HI 762L/10** General purpose/liquid temperature probe with 10 m cable

ACCESSORIES

- HI 762-18C** Test key at -18.0°C
- HI 762000C** Test key at 0.0°C
- HI 762070C** Test key at 70.0°C
- HI 710005** 115 Vac/12 Vdc power adapter
- HI 710006** 230 Vac/12 Vdc power adapter
- HI 710034** Paper roll (10)
- HI 710035** Ink cartridge
- HI 9200/9** Serial IR interface for PC connection
- HI 92000** Windows® compatible software
- HI 710031** Rugged carrying case



HI 710035 Ink Cartridge

Windows® is registered Trademark of "Microsoft Co."

HI 9060

Thermistor Thermometer

Waterproof and Rugged



Ideal for Wet and Humid Environments

The waterproof HI 9060 thermistor thermometer is ideal for use in wet and humid environments. This popular instrument is configured with a dual-level LCD that shows the current temperature simultaneously with the high and low session extremes. A HOLD button allows easy recording of the current information on display.

Toggle between degrees Celsius and degrees Fahrenheit, simply by pushing the °C/°F button.

This rugged instrument offers a new level of portability with an increase in battery life to 3000 hours! That means the instrument will work up to 8 hours a day, seven days a week for over a year. At startup, the thermometer performs a self test and displays the remaining battery power.

The waterproof HI 9060 uses a thermistor sensor for measuring the temperature in a range from -50 to 150°C and -58 to 302°F.

HANNA produces a complete range of interchangeable HI 765 probes to meet all of your application needs.

- *HOLD button freezes readings on the display*
- *Switch between °C and °F at the touch of a button*
- *Battery life on display*
- *3000 hour battery life*

Specifications	HI 9060
Range	-50.0 to 150.0°C; -58.0 to 302.0°F
Resolution	0.1°C; 0.1°F
Accuracy	±0.4°C; ±0.8°F (for 1 year, excluding probe error)
Probe	HI 765BL, stainless steel, with 1 m (3.3') cable (included)
Battery Type / Life	(4) 1.5V AA / approx. 3000 hours of continuous use
Environment	-10 to 50°C (14 to 122°F); RH max 100%
Dimensions	196 x 80 x 60 mm (7.7 x 3.1 x 2.4")
Weight	500 g (1.1 lbs.)

ORDERING INFORMATION

HI 9060 is supplied with HI 765BL temperature probe, batteries (4) and instruction manual.

PROBES

- HI 765BL** General purpose/liquid temperature probe with 1 m cable
- HI 765L/10** General purpose/liquid temperature probe with 10 m cable

ACCESSORIES

- HI 765-18C** Test key at -18.0°C
- HI 765000C** Test key at 0.0°C
- HI 765070C** Test key at 70.0°C
- HI 710021** Spare protective case
- HI 721317** Rugged carrying case



HI 765 Test Keys



HI 9063

K-Type Thermocouple Thermometer

Waterproof, Heavy-Duty

Thermometers
Portable Meters

Designed for Heavy-Duty Applications

Instrumentation used in the field or industry is subject to environmental extremes. Due to this problem, HANNA has developed the HI 9063 to satisfy all of your heavy-duty application needs.

This upgraded version of HI 9063 benefits from HANNA extensive experience in producing instruments that surpass the competition. The measurement ceiling has been raised, auto-ranging added and accuracy enhanced.

Because it is often necessary to know the highest and lowest temperatures measured during a certain process, HANNA has incorporated a dual-level LCD that shows the current, minimum and maximum achieved temperatures.

Temperature readings are linearized for increased accuracy and resolution is automatically switched from 0.1° to 1° at 200°C (400°F) and above.

- *HOLD button freezes readings on the display*
- *View High, Low and Current Readings Simultaneously*
- *Autoranging*
- *Enhanced accuracy*



HI 721317 Rugged Carrying Case

Specifications	HI 9063 • HI 9063C
Range	-50.0 to 199.9°C; 200 to 1350°C -58.0 to 399.9°F; 400 to 2462°F
Resolution	0.1°C (-50.0 to 199.9°C); 1°C (outside) 0.1°F (-58.0 to 399.9°F); 1°F (outside)
Accuracy	±0.2% F.S. (for 1 year, excluding probe error)
Probe	K-thermocouple type, HI 766 series
Battery Type / Life	(4) 1.5V AA / approx. 2000 hours of continuous use
Environment	-10 to 50°C (14 to 122°F); RH max 100%
Dimensions	196 x 80 x 60 mm (7.7 x 3.1 x 2.4")
Weight	500 g (1.1 lbs.)

ORDERING INFORMATION

HI 9063 is supplied with batteries (4) and instruction manual.

HI 9063C is supplied with HI 766HD probe handle, HI 766PE1, HI 766PB, HI 766PD probes, batteries, rugged carrying case and instructions.

PROBES

HI 766C Penetration, K-thermocouple probe with 1 m cable

HI 766E1 General purpose, K-thermocouple probe with 1 m cable

ACCESSORIES

HI 710021 Spare protective case

HI 721317 Rugged carrying case

HI 141

Temperature Dataloggers

with 1 or 2 channels, internal or external sensor, with or without LCD



At a glance, you can assess the current temperature, channel and status of the logging sequence according to your programmed instructions:

- Number of samples taken
- Countdown until the start of logging
- Number of samples which have exceeded the HIGH/LOW alarms
- HIGH and LOW temperature values
- HIGH and LOW alarm settings

Available in Multiple Configurations

The HI 141 series is a family of temperature data loggers with either one or two channels, internal or external temperature sensors, and an optional LCD. External temperature sensor models feature one or two stainless steel sensors on a 1m (3.3') cable for direct insertion. HI 141 can store up to 16,000 temperature samples in a protected, non-volatile EEPROM memory. The logging interval can be set from once per second to once per 24 hour period, and logging delay can be set anywhere up to 199 hours. The MIN or MAX temperature between logging intervals can also be stored. All of your collected data is tamper-proof and stored into serial numbered lots.

The user interacts with the logger, setting data acquisition parameters or down-loading logged data through an RS232 serial port on a Windows® PC. The HI 141000 Windows® compatible software supports communication between the logger and the PC through the HI 141001 infrared transmitter.

The housing is waterproof and can include a convenient hanging hook (simply add an "H" to the end of the code). A long-life AA lithium battery provides power. For a typical 1 minute logging interval, your battery will last about 4 years.

Models with a longer cable for external sensors are available upon request.

- 1 or 2 channels with internal or external sensor
- 16,000 samples/channel (for 1-channel models) or 8,000 samples/channel (for 2-channel models)
- Logging interval from 1 second to 24 hours
- Logging delay start up to 199 hours and magnetic start
- Programmable high and low alarms
- Non-volatile storage of logging parameters and data in EEPROM
- IP67 waterproof casing

Specifications Model	Display	Sensor(s)	Range
HI 141A (H)		1 internal	-40.0 to 80.0°C / -40.0 to 176.0°F
HI 141B* (H)		1 external	-40.0 to 125.0°C / -40.0 to 257.0°F
HI 141C (H)	•	1 internal	-20.0 to 70.0°C / -40.0 to 158.0°F
HI 141D (H)	•	1 external	-40.0 to 125.0°C / -40.0 to 257.0°F
HI 141E* (H)		1 internal 1 external	-40.0 to 80.0°C / -40.0 to 176.0°F -40.0 to 125.0°C / -40.0 to 257.0°F
HI 141F* (H)		2 external	-40.0 to 125.0°C / -40.0 to 257.0°F
HI 141G* (H)	•	1 internal 1 external	-20.0 to 70.0°C / -40.0 to 158.0°F -40.0 to 125.0°C / -40.0 to 257.0°F
HI 141J* (H)	•	2 external	-40.0 to 125.0°C / -40.0 to 257.0°F

Specification for all models	
Resolution	0.1°C (-40.0 to 100.0°C); 0.2°C (> 100.0°C) 0.1°F (-40.0 to 190.0°F); 0.3°F (> 190.0°F)
Accuracy	±0.5°C (-40.0 to 0.0 and 70.0 to 100.0°C); ±0.4°C (0.0 to 70.0°C); ±1.0°C (> 100.0°C) ±1.0°F (-40.0 to 32.0 and 158.0 to 212.0°F); ±0.8°F (32.0 to 158.0°F); ±2.0°F (> 212.0°F)
Environment	RH 100%
Diameter	86.5 mm (3.4")
Height	35 mm (1.4")
Weight	150 g (5.5 oz.)

ORDERING INFORMATION

All HI 141 models are supplied with 3.6V Lithium AA battery, magnetic key and instructions.

ACCESSORIES

- HI 141000** Windows® compatible software
- HI 740033** 3.6 V AA lithium battery
- HI 141001** Infrared interface for PC connection
- HI 740221** Key for HI 141 magnetic start

* Models with different cable lengths are available upon request. Contact your nearest HANNA dealer.



HI 143
T-Logger
with locking wall cradle

Secure Temperature Logger

HI 143 is a temperature data logger with internal NTC sensor. The HI 143 is controlled via USB on a PC with HANNA's Windows® compatible application software. Communication is made between the logger and the PC through the HI 143001 transmitter with RS232 or HI 143002 with USB connector. The supplied wall cradle makes it easy to lock the meter in place to prevent tampering and the application software supports security passwords.

- *Logging start through PC*
by pressing a button or at a set time
- *Selectable sampling interval*
from 1 minute to 24 hours
- *Up to 4,000 logged samples*
- *Selectable measurement unit*,
°C or °F
- *Min/Max* measured values are stored
and displayed
- *Programmable high and low alarms*
- *Non-volatile storage*
of logging parameters and data
- *Battery level indicator on display*
- *Security password*
- *IP 65 protection*



ORDERING INFORMATION

HI 143 is supplied with CR2032 lithium battery, wall cradle, lock and instructions.

HI 143-00 is supplied with HI 143002 USB communication cradle, Windows® compatible application software, CR2032 lithium battery, wall cradle, lock and instructions.

HI 143-10 is supplied with HI 143001 RS232 communication cradle, Windows® compatible application software, CR2032 lithium battery, wall cradle, lock and instructions.

ACCESSORIES

HI 143002 USB communication cradle.

HI 143001 RS232 communication cradle.

Specifications	HI 143
Range	-30. to 70.0°C/-22.0 to 158.0°F
Resolution	0.1°C/0.1°F
Accuracy	±0.4°C (-20 to 60°C); ±0.6°C (outside) ±0.7°F (-4 to 140°F); ±1.1°F (outside)
Calibration	Factory calibrated
Datalogging	Up to 4,000 samples
Logging interval	User selectable, from 1 minute to 24 hours
Battery Type / Life	(1) CR2032 3V lithium ion/approx. 2 years
Protection	IP 65 (watertight)
Dimensions	60 x 37 x 17 mm (2.4 x 1.5 x 0.7")



Checktemp® Digital Thermometer

for Quick Results

Did you ever wish that your temperature measurements could be made a little easier, with better accuracy over a wider range without worrying about breakage or condensation? Checktemp® might just be what you have been looking for!

The Checktemp® offers NO breakage, NO waste, NO injuries, NO difficulty in reading; not even a parallax error by taking a wrong measurement due to the angle of view!

Checktemp® is provided with the unique calibration check function: simply activate the proper switch and the instrument will simulate a 0.0°C (32.0°F) signal that has to be read on the LCD within a range of ±0.3°C (±0.5°F). This system guarantees the accuracy of your measurement at any time!

The sharp-tip probe can easily penetrate semisolid products, making routine controls simple and quick for both incoming and outgoing goods. Checktemp® is the ideal instrument for measuring temperature according to HACCP requirements.

- CAL CHECK™
- Ideal for Spot Checks
- Fast and Accurate Results



SPECIFICATIONS	HI 98501 (Checktemp C)	HI 98502 (Checktemp F)	HI 98505 (Checktemp L C)	HI 98506 (Checktemp L F)
Range	-50.0 to 150.0°C	-58.0 to 302.0°F	-50.0 to 150.0°C	-58.0 to 302.0°F
Resolution	0.1°C	0.1°F (58.0 to 199.9°F); 1°F (200 to 302°F)	0.1°C	0.1°F (58.0 to 199.9°F); 1°F (200 to 302°F)
Accuracy	±0.3°C (-20 to 90°C) ±0.5°C (outside)	±0.5°F (-4 to 194°F) ±1°F (outside)	±0.3°C (-20 to 90°C) ±0.5°C (outside)	±0.5°F (-4 to 194°F) ±1°F (outside)
Probe	fixed, stainless steel; 105 x dia 3 mm (4.1 x dia 0.1") (penetration)	fixed, stainless steel; 105 x dia 3 mm (penetration)	fixed, stainless steel; 105 x dia 3 mm (liquid)	fixed, stainless steel; 105 x dia 3 mm (liquid)
Battery Type / Life	1 x 1.5V / approx. 3000 hours of continuous use			
Environment	0 to 50°C (32 to 122°F); RH max 95%			
Dimensions / Weight	66 x 50 x 25 mm (2.6 x 2.0 x 1.0") / 50 g (1.8 oz.) - meter only			

The Checktemp® L models feature a round tip probe for liquid measurements.

ORDERING INFORMATION

HI 98501 (Checktemp® C) is supplied with penetration probe, protective cap, battery and instructions.

HI 98502 (Checktemp® F) is supplied with penetration probe, protective cap, battery and instructions.

HI 98505 (Checktemp® L C) is supplied with probe for liquid measurement, protective cap, battery and instructions.

HI 98506 (Checktemp® L F) is supplied with probe for liquid measurement, protective cap, battery and instructions.



ORDERING INFORMATION

HI 147-00 (Checkridge C) is supplied complete with battery and instructions.

HI 147-01 (Checkridge F) is supplied complete with battery and instructions.

Checkridge Digital Temperature Monitor

With Magnetic Backing

The HI 147 is the ideal choice when you need accurate and reliable temperature monitoring.

- Magnetic Backing
- Food Grade Stainless Steel Thermistor Probe on 1m Cable
- Fast Response
- CAL CHECK™ Verification
- Low Battery Warning
- Perfect for Refrigerator and Freezer Monitoring

SPECIFICATIONS	HI 147-00 Checkridge C	HI 147-01 Checkridge F
Range	-50.0 to 150.0°C	-58.0 to 302.0°F
Resolution	0.1°C	0.1°F (-58.0 to 199.9°F) 1°F (200 to 302°F)
Accuracy	±0.3°C (-20 to 90°C); ±0.5°C (outside)	±0.6°F (-4 to 194°F); ±1°F (outside)
Calibration Check	manual, through switch	
Probe	stainless steel, general purpose; 40 x dia 5 mm (1.6 x dia 0.2"); 1 m (3.3') cable	
Battery Type / Life	(1) 1.5V AAA / approx. 3 years of use	
Environment	0 to 50°C (32 to 122°F); RH max 95%	
Dimensions (meter only)	93 x 39 x 31 mm (3.7 x 1.5 x 1.2")	
Weight	60 g (2.1 oz.)	

Warranty

Limited Warranty/Product Return and Exchange

Limited Warranty

HANNA products are manufactured in our ISO 9001:2000 facilities, meeting the highest quality standards in the industry. HANNA's high standards also apply should a product be returned due to defects in material or workmanship. Our extensive warranty extends up to five years on some products.

Limitations: Warranted products may be returned for repair or replacement only at the discretion of HANNA. In some circumstances, remedy may constitute refund for the price paid for the product.

The warranty period commences from the original date of sale to the user or a maximum of 18 months from factory ship date. Warranty is valid only when the product is used under normal conditions and in accordance with operating limitations and prescribed maintenance procedures. The express warranty stated previously is the only express warranty given by HANNA to the end-user buyer. HANNA expressly disclaims any warranties implied by law, including but not limited to warranty of merchantability of fitness for a particular purpose. HANNA shall not be liable for any individual or consequential damages of any kind for breach of any warranty, negligence, on the basis of strict liability or otherwise. HANNA's warranty periods differ across our range of instrumentation, please visit us on the web at: www.hannainst.com or contact your local HANNA representative for specific warranty information.

Instrument Service:

Warranty and non-warranty service, replacement, recalibration and repairs are performed by factory trained service technicians at one of HANNA's Technical Service Centers worldwide. All items must have a Return Goods Authorization (RGA) number that can be obtained by contacting the HANNA Technical Service Department. The RGA number should be clearly marked on the outside of the box and the unit shipped prepaid and insured. Any product not bearing an RGA number will be refused. All products returned for warranty repair or replacement MUST be preceded or accompanied with proof of purchase, such as the original invoice or packing slip. Under special circumstances it may be deemed necessary by HANNA to issue a Return In Advance (RIA). In such cases, the defective materials must be returned to HANNA within 30 days. Materials not returned within 30 days become chargeable. Materials must be packed properly to avoid damage during transport, which would render the warranty null and void. The sender is responsible for expediting any damage claims placed against the carrier.

In most cases, a flat minimum service charge applies to non-warranty repairs or recalibration. Please contact your local HANNA Technical Service Department for current rates. Any materials returned for repair which are considered non-warranty may be serviced at hourly cost (excluding parts) following subsequent notification and approval of such.

Product Return and Exchange

Returning Merchandise:

Should an instance occur when a product may need to be returned for exchange or credit, or should a discrepancy occur in a packing slip, HANNA must be contacted to obtain a Return Goods Authorization Number (RGA). Please follow these steps:

1. Within 30 days of receipt of merchandise call HANNA's Technical Service Department to obtain a Return Goods Authorization Number.
2. HANNA will issue a Return Goods Authorization Number.
3. The number must be clearly marked on the outside of the package being returned. Shipments not bearing a Return Goods Authorization Number will be refused.
4. Credit returns may be subject to a 25% restocking fee.

Terms and Conditions

Return shipments must meet the following requirements to be accepted for credit:

1. Products must be returned in the original packaging with labeling not defaced. All items returned will be inspected for credit worthiness. Credit will only be issued for product returned in like-new condition. No credit will be issued for product, which is not received in like-new condition.
2. All freight charges are the responsibility of the customer.
3. All chemicals and reagents being returned must be packaged in accordance with the laws and regulations of the governing country. Only unopened chemicals and reagents may be returned.

Guide to Symbols



pH Condition
Verify the pH/ORP electrode condition



Check Electrode
Verify the pH/ORP electrode status



Validation
Verification and calibration system for photometers



Fast Tracker
Features HANNA's T.I.S. — Tag Identification System



Custom Buffer
Enter custom buffers for calibration



2 Points
Calibration can be performed at 1 or 2 points



3 Points
Calibration can be performed at 1 to 3 points



4 Points
Calibration can be performed at 2 to 4 points



5 Points
Calibration can be performed at 1 to 5 points



Hold
Freeze reading on the display



Audible
Acoustic signal



Backlight
Backlit display



Replaceable
Tester with replaceable probe



Min/Max
Store and continuously display min and max readings



CAL 0°C
Calibration check at 0°C (32°F)



PC Compatible via USB
PC compatible via USB port with optional HANNA software



PC Compatible
PC compatible with optional HANNA software



Battery
Remaining battery life indication



BEPS (Battery Error Prevention System)
Automatically turns the meter off to avoid erroneous readings due to low battery level



 **HANNA[®]**
instruments
With Great Products, Come Great Results™
.....
www.hannainst.com